

AUDIO & VIDEO DOOR ENTRY SYSTEMS



CATALOGUE

KITS AND SYSTEM SOLUTIONS FOR SINGLE
HOUSES, BUILDINGS AND COMPOUNDS



BTICINO

Specialists in Video Door Entry Systems

BTicino, introduces a complete range of products and systems capable of meeting all application and building requirements. From single homes to larger buildings and apartment complexes, BTicino can offer the right solution to satisfy both the private user and the professional.

Index

4-5	Offer overview	Different solutions for different applications	4
6-33	EASYKIT	EASY KITS (two wires)	6
34-43	BASIC KITS	BASIC KITS (four wires)	34
44-57	PROFESSIONAL KITS	Features overview	44
		Villa CONNECTED VIDEO KITS (two wires)	48
		Villa VIDEO KITS (two wires)	52
		Villa AUDIO KITS (two wires)	54
		Villa ANALOGUE AUDIO KITS	56
58-119	2 Wires System	System overview	58
		Entrance panels range	62
		Internal units range	84
		System accessories range	114
120-140	IP System	System overview	120
		Entrance panels range	128
		Internal units range	130
		Guard station and accessories range	134

DIFFERENT SOLUTIONS FOR DIFFERENT APPLICATIONS

EASYKIT - BASIC KITS

for standard level villas



Closed solution that provides **BASIC FUNCTIONS**, normally for simple systems:



- ONE OR TWO FAMILY HOMES
- READY MADE SOLUTIONS
- EXPANDABLE SOLUTIONS
- PLUG-IN OR DIN POWER SUPPLY

PROFESSIONAL KITS

for high level villas



Initial basic solution that **CAN DEVELOP** into a **MORE COMPLEX** and **CUSTOMISED** systems:



- ONE OR TWO-FAMILY HOMES
- READY MADE SOLUTIONS
- FULLY EXPANDABLES
- ENHANCED FUNCTIONS

From villas to multi-family units



Villas

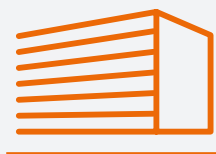

Small building



Building complex

Different types of constructions mean different types of offer

2 WIRES SYSTEM

for small buildings



The best technology when **TIME SAVING** and **EASE** of **INSTALLATION** are required:



- SMALL BUILDINGS/HOMES
- EASY AND QUICK TO INSTALL
- MAXIMUM VERSATILITY
- PERFECT FOR REFURBISHMENTS

IP SYSTEM

for building complex



The system conceived for **BIG RESIDENTIAL BUILDINGS** where IP cabling is required.



- LARGER BUILDINGS AND COMPLEXES
- HIGH PERFORMANCES
- LONG DISTANCES AND HIGH NUMBER OF APARTMENTS
- INTEGRATED SECURITY FUNCTIONS

EASYKIT

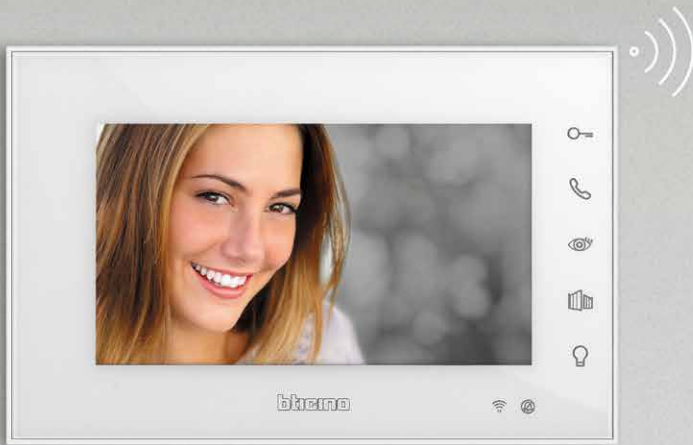

- **Easy** installation
- **Expandability** with additional internal units, entrance panel and CCTV camera
- **Connected Wifi** solution available
- **Door lock** release key and **intercom functions**
- **Plug-in** and **DIN** power supply



EASYKIT

“very simple” solutions



Hands-free video kits comprising:

- a wall-mounting metal entrance panel (rainshield included) equipped with a colour camera and a LED lamp for the illumination of the field of view.
- a video colour display internal unit (plug-in power supply included).

Main features:

- Easy, simple and quick installation
- SMART Wifi connected solution for your security
- 2 non-polarized wires for an error-proof connection
- Practical and functional: hands-free solutions enabling dialogue while moving freely
- High-resistant, waterproof metal entrance panels
- One family installation. Easy switch to two families by adding the additional internal unit
- Expandability with additional internal units, entrance panel and CCTV camera.

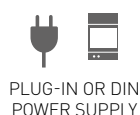
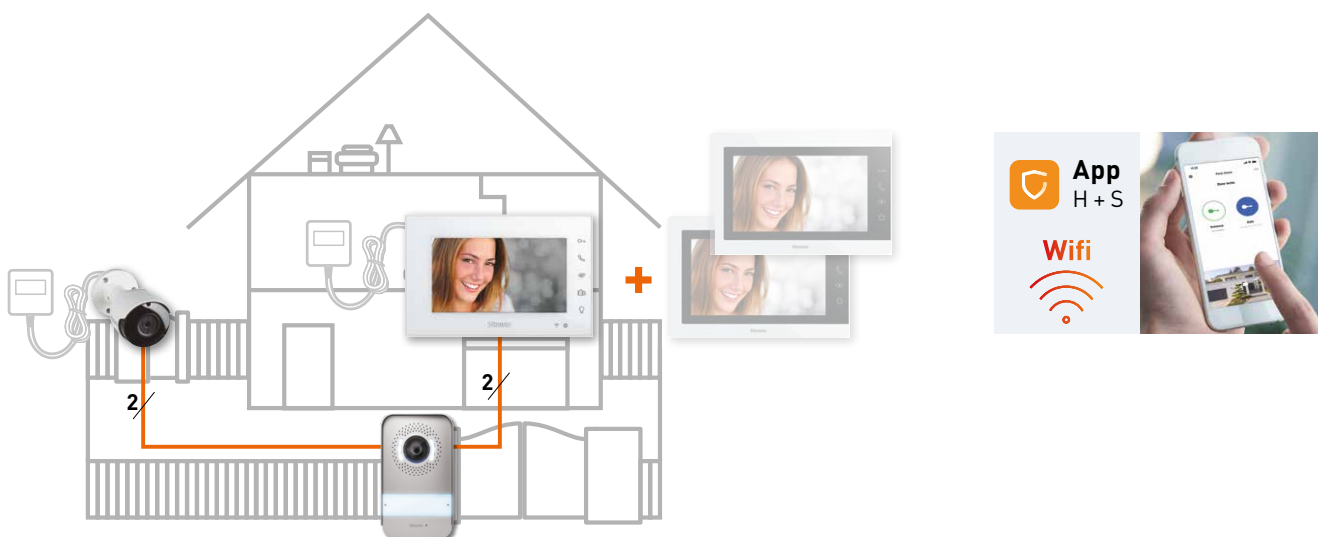



Easykit Wifi

SMART SOLUTION
FOR YOUR SECURITY



Home + Security



Answer the calls,
activate the electrical door locks,
activate the cameras and display
the timeline of the events

Manage up to 20 homes
with your single account



Home + Security



Incoming call

Receive notification
when someone
is calling

See who's calling

Answer the call and
open the gate for
the courier

Check the events

Check who called you
and if they left you
a message

Quick actions

- Activate the electrical door locks
- Activate the timed staircase lights
- Call home / Intercom
- Activate the cameras

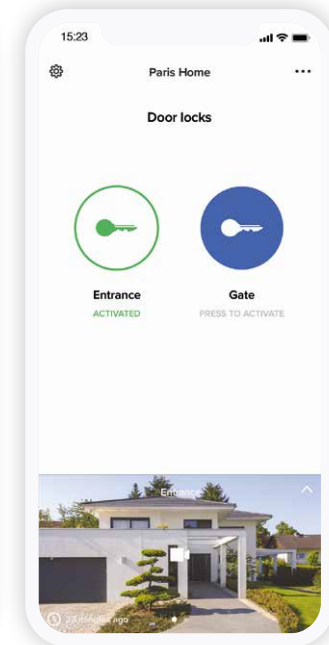
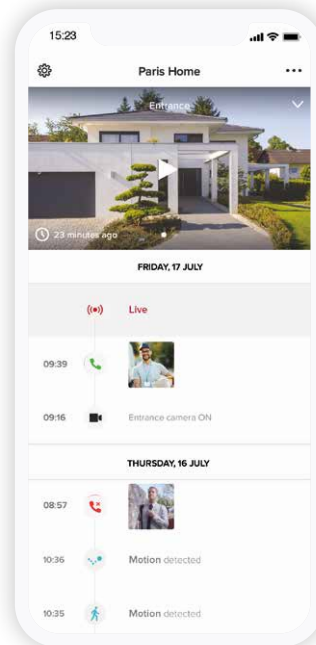
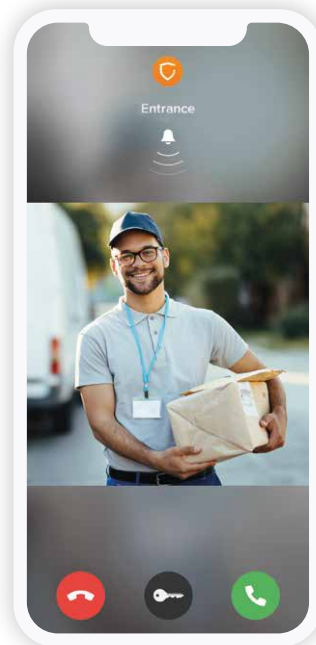
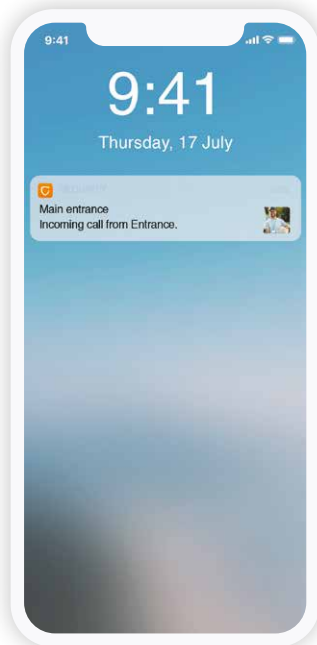

Security enhancement with integration of Netatmo devices

Video door entry system and security. Together.

Video door entry system ...



Main entrance
Incoming entrance call.

Security ...



Secondary entrance and interiors
Smart Outdoor Camera with Siren and movement detection. Smart Indoor Camera with face recognition.

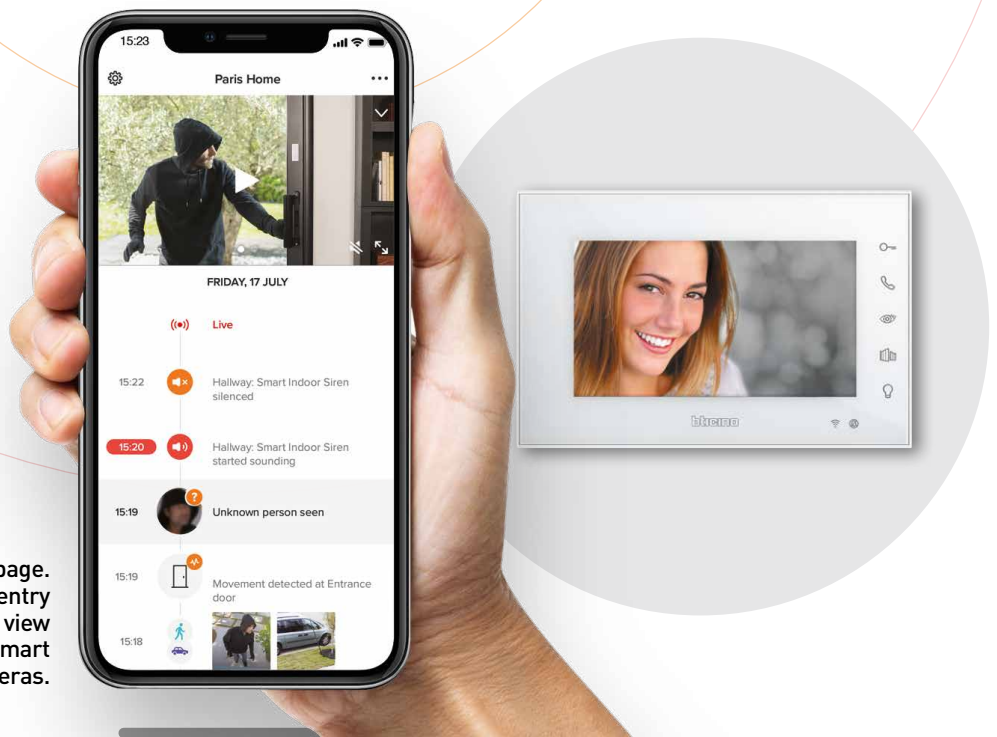

A single App with an intuitive home page. It allows you to answer video door entry calls, activate the door lock and view images from Netatmo smart outdoor and indoor cameras.



Professional opportunity: offer your services as an installer of simple smart security systems.
Business opportunities: access to a catalogue of smart and easy-to-install security devices.

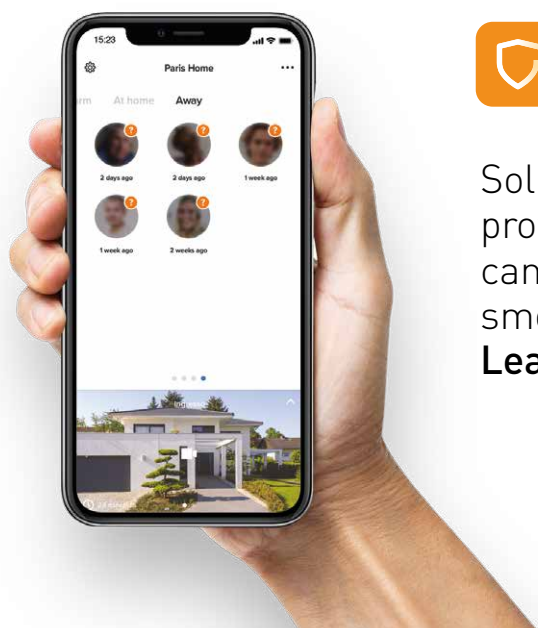

Home + Security
The best App for a safe home.

Solutions for a smart and complete protection of your home: security cameras, alarms, opening sensors, smoke detector...

Leave your home without worries.

WITH
Netatmo

Examples of Netatmo solutions natively integrated in the Home + Security App



Smart Outdoor Camera



Smart Outdoor Camera with Siren



Smart Indoor Camera



Smart Door and Window Sensors



Smart Video Doorbell



Smart Indoor Siren



Smart Smoke Alarm



Smart Carbon Monoxide Alarm

BTICINO BRAND KITS



EXISTING INTERNAL UNIT

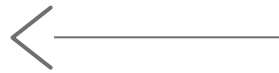

EXISTING INTERNAL UNIT

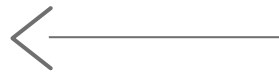

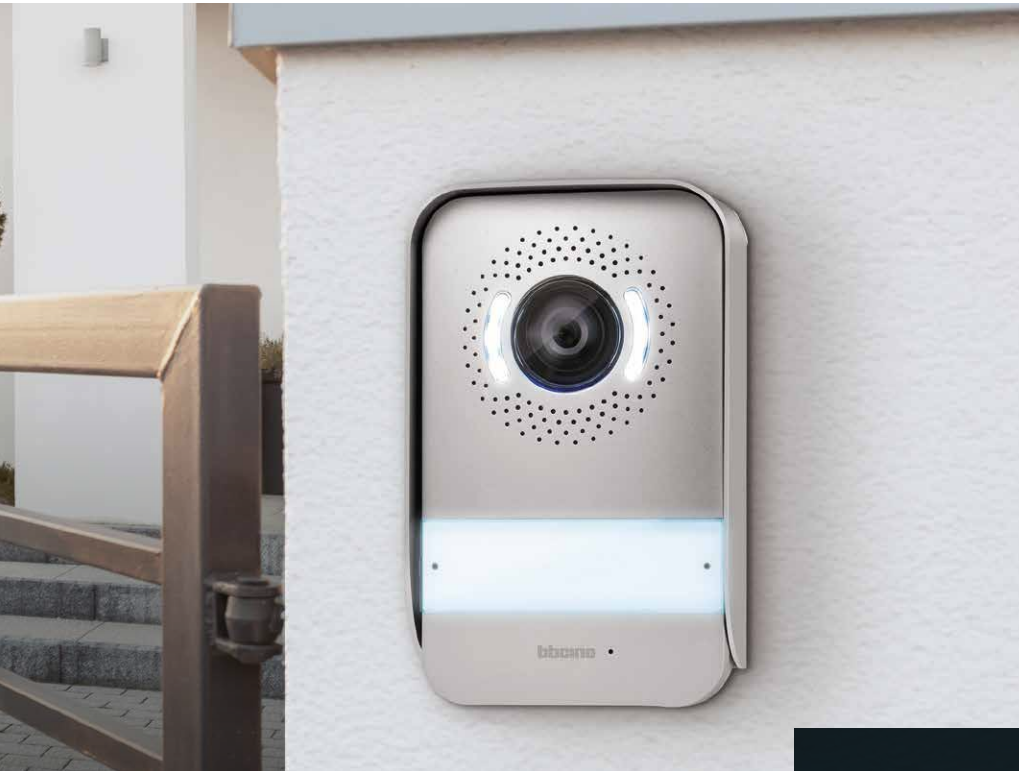

You can turn your existing system into a connected one by simply replacing the video internal unit **without structural changes.**

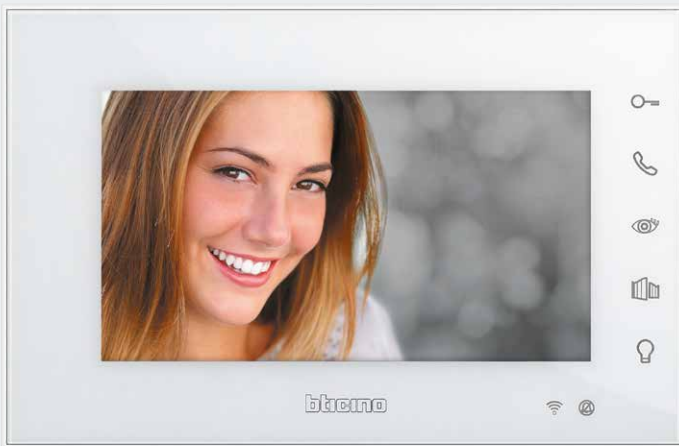

CONNECTED INTERNAL UNIT

BT-335253
BT-335254



EASYKIT SOLUTIONS

CHOOSE YOUR KIT...

7" inch easykit Wifi video kits



- Wifi connectivity
- Management from smartphone via Home + Security app
- 7 Inch colour monitor with soft touch buttons
- White finish
- Double opening (door and gate)
- Light activation
- Integration with Netatmo Smart Cameras and Security devices
- Additional CCTV camera
- Entrance panel can call 2 apartments
- Plug-In or DIN power supply

7" inch easykit plus video kits



- Simple and modern
- 7 Inch colour monitor with soft touch buttons
- Mirror effect design
- Black finish
- Double opening (door and gate)
- Light activation
- Additional CCTV camera
- Entrance panel can call 2 apartments
- Plug-In or DIN power supply

7" mirror effect / white finish video kits





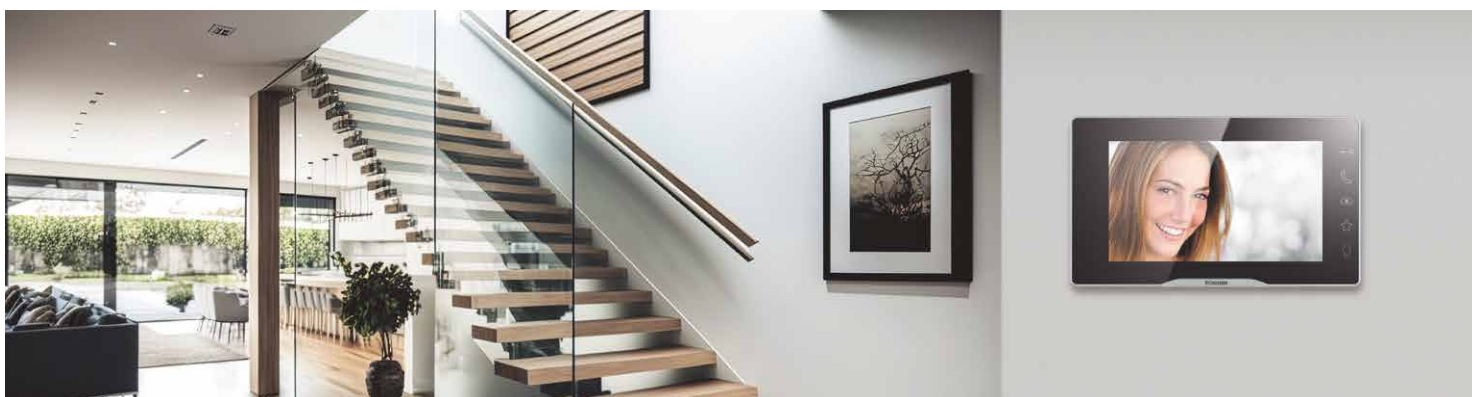

- Practical and essential
- 7 Inch colour monitor with soft touch buttons
- White finish
- Double opening (door and gate)
- Additional CCTV camera
- Entrance panel can call 2 apartments
- Plug-In or DIN power supply



AND EXPAND IT

All Easykits can be expanded up to a maximum of 3 internal units and one additional entrance panel or CCTV camera for each apartment. Only one easy kit connected per home can be installed.

7 Inch Wifi additional internal units	7 Inch Plus additional internal units	7 Inch Essential additional internal units	Additional entrance panel additional camera
 <p>Plug-In or DIN Power supply</p>	 <p>Plug-In or DIN Power supply</p>	 <p>Plug-In or DIN Power supply</p>	 <p>ENTRANCE PANEL durable aluminium finishing</p> <ul style="list-style-type: none"> ■ Practical 2-wires installation ■ Weatherproof (IP54) ■ Metal protective rainshield ■ IK07 degree of protection ■ Wide-angle camera (105°) ■ LED light and night vision ■ Adaptable for one or two-family houses ■ Can be connected to a security camera



EASYKIT

WITH PLUG-IN POWER SUPPLY

2 WIRES



7" WHITE FINISH **EASYKIT Wifi with Netatmo** WITH PLUG-IN POWER SUPPLY

One family two wires colour **EASYKIT Wifi with Netatmo** connected video kit with plug-in power supply and wall mounted entrance panel that can be easily adapted for two family houses. An external CCTV colour camera can be directly connected to the entrance panel. Wifi connected handsfree 7" screen internal unit white finish with European Plug-In power supply included. The system can be expanded up to 3 traditional handsfree internal units. Thanks to the Wifi connection, you can associate the video internal unit to the HOME + SECURITY App (available for Android and iOS). You can manage by the App the main video internal unit functions (receiving calls, opening the door lock, view the cameras). Through the same App, it is also possible to manage the products of the Netatmo security range (outdoor and indoor cameras, door and window sensors, indoor siren and smoke detector).

This allows you to quickly and easily create a Smart security system.



7" MIRROR BLACK FINISH **EASYKIT PLUS** WITH PLUG-IN POWER SUPPLY

One family two wires colour **EASYKIT Plus** video kit with plug-in power supply and wall mounted entrance panel that can be easily adapted for two family houses.

An external CCTV colour camera can be directly connected to the entrance panel. Handsfree 7" screen internal unit black finish mirror effect, with touch control commands for main functions and European Plug-In power supply included.

The system can be expanded up to 3 traditional handsfree internal units.







7" WHITE FINISH **EASYKIT ESSENTIAL** WITH PLUG-IN POWER SUPPLY

One family two wires colour **EASYKIT Essential** video kit with plug-in power supply and wall mounted entrance panel that can be easily adapted for two family houses.

An external CCTV colour camera can be directly connected to the entrance panel. Handsfree 7" screen internal unit white finish with touch control commands for main functions and European Plug-In power supply included. The system can be expanded up to 3 traditional handsfree internal units.

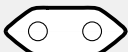



PLUG-IN PWS (included)	EASYKIT Wifi with Netatmo	EASYKIT PLUS	EASYKIT ESSENTIAL
European standard 	BT-310913 7 inch white finish screen Wifi with Netatmo KIT	BT-318913 7 inch black finish screen Plus KIT	BT-317913 7 inch white finish screen Essential kit
	BT-335253 7 inch white finish additional Wifi with Netatmo Internal unit	BT-334253 7 inch black finish additional Plus Internal unit	BT-333253 7 inch white finish additional Essential Internal unit
Video colour entrance panel 	BT-331860 (Additional colour entrance panel with rainshield)		
Additional External camera 	BT-391441 (European standard PLUG Colour external camera)		
Spare part Power supply 	BT-SP101 (Spare part plug-in power supply)		



NOTE: internal units are all compatible. As additional internal unit you can use any of the range.

BTICINO BRAND KITS

EASYKIT with PLUG-IN POWER SUPPLY



BT-310913



BT-318913



BT-317913



BT-335253



BT-334253



BT-333253

Item **7" White finish EASYKIT Wifi with plug-in power supply**

BT-310913 One family two wires colour **EASYKIT Wifi connected video kit with plug-in power supply and wall mounted entrance panel.** Metal finish entrance panel with rainshield, colour wide angle camera and LED for the night illumination of the field of view. Entrance panel can be easily adapted for two family houses. An external CCTV colour camera can be directly connected to the entrance panel.

Wifi connected handsfree 7" screen internal unit white finish with European PLUG-IN std power supply included. The system can be expanded up to 3 traditional handsfree internal units.

Thanks to the Wifi connection, you can associate the video internal unit to the Home + Security App (available for Android and iOS). You can manage by the App the main video internal unit functions (receiving calls, opening the door lock, view the cameras). Through the same App, it is also possible to manage the products of the Netatmo security range (outdoor and indoor cameras, door and window sensors, indoor siren and smoke detector). This allows you to quickly and easily create a Smart security system.

Additional video internal units

BT-335253 **Additional EASYKIT Wifi connected handsfree 7" screen internal unit white finish** with EU standard plug-in power supply included. Touch control commands for main functions. Wall mounting installation. Thanks to the Wifi connection, you can associate the video internal unit to the Home + Security App (available for Android and iOS).

BT-334253 **Additional EASYKIT Plus handsfree 7" screen internal unit black finish mirror effect** with EU standard plug-in power supply included. Touch control commands for main functions. Wall mounting installation.

BT-333253 **Additional handsfree 7" EASYKIT Essential screen internal unit white finish** with EU standard plug-in power supply included. Touch control commands for main functions. Wall mounting installation.

Item **7" Mirror black finish EASYKIT Plus with plug-in power supply**

BT-318913 One family two wires colour **EASYKIT Plus video kit with plug-in power supply and wall mounted entrance panel.** Metal finish entrance panel with rainshield, colour wide angle camera and LED for the night illumination of the field of view. Entrance panel can be easily adapted for two family houses. An external CCTV colour camera can be directly connected to the entrance panel.

Handsfree 7" screen internal unit black finish mirror effect, with touch control commands for main functions and European PLUG-IN std power supply included. The system can be expanded up to 6 internal units (3 per entrance panel) and up to 2 entrance panels.

BT-317913 **7" Mirror black finish EASYKIT Essential with plug-in power supply**

One family two wires colour **EASYKIT Essential video kit with plug-in power supply and wall mounted entrance panel.** Metal finish entrance panel with rainshield, colour wide angle camera and LED for the night illumination of the field of view. Entrance panel can be easily adapted for two family houses. An external CCTV colour camera can be directly connected to the entrance panel.

Handsfree 7" screen internal unit white finish with touch control commands for main functions and European PLUG-IN std power supply included. The system can be expanded up to 6 internal units (3 per entrance panel) and up to 2 entrance panels.



BT-331860



BT-391441



BT-SP101

Wiring diagram example

- Item Additional video entrance panel with rainshield**
- BT-331860** Additional video colour entrance panel with rainshield. Wide angle colour camera (105°). IP54 Protection degree.
- Additional external camera**
- BT-391441** Additional external colour camera with coaxial video output, metal case and 3.6 mm fixed lens. Night vision. Power supply 100-240 Vac / 50-60 Hz (12 VDC Plug-in power supply with EU standard socket supplied). Degree of protection IP66 – degree of robustness IK07. Can be connected directly to the entrance panel.
- Plug-In power supply**
- BT-SP101** Plug-In power supply with EU Standard plug. Nominal input voltage : 110 - 240 Vac @ 50/60 Hz. Output : 30 Vdc - 1 A. Integrated fuse on PRI side (F1 T2A 250 V).

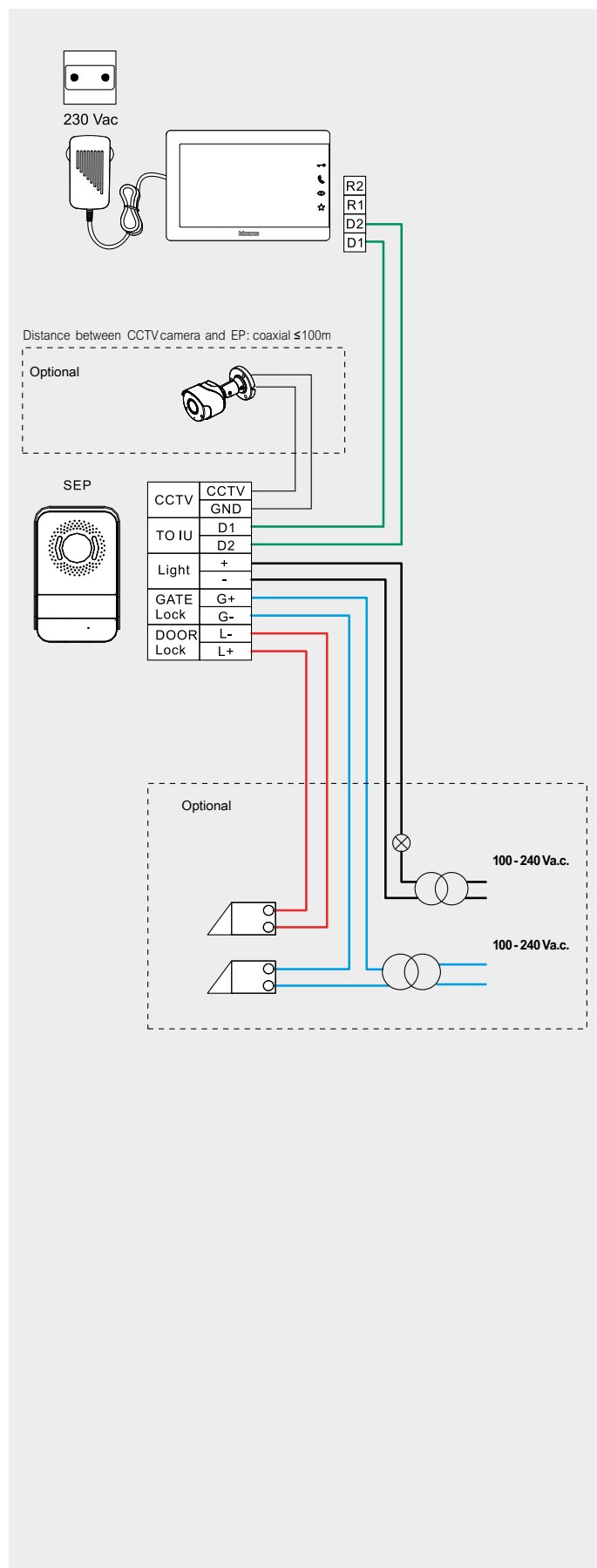

EASYKIT

WITH DIN POWER SUPPLY

2 WIRES



7" WHITE FINISH EASYKIT Wifi with Netatmo WITH DIN POWER SUPPLY

One family two wires colour **EASYKIT Wifi with Netatmo** connected video kit with 2-DIN modules power supply and wall mounted entrance panel that can be easily adapted for two family houses.
An external CCTV colour camera can be directly connected to the entrance panel. Wifi connected handsfree 7" screen internal unit white finish.
The system can be expanded up to 3 traditional handsfree internal units.
Thanks to the Wifi connection, you can associate the video internal unit to the HOME + SECURITY App (available for Android and iOS). You can manage by the App the main video internal unit functions (receiving calls, opening the door lock, view the cameras). Through the same App, it is also possible to manage the products of the Netatmo security range (outdoor and indoor cameras, door and window sensors, indoor siren and smoke detector).
This allows you to quickly and easily create a Smart security system.



7" MIRROR BLACK FINISH EASYKIT PLUS WITH DIN POWER SUPPLY

One family two wires colour **EASYKIT Plus** video kit with 2-DIN modules power supply and wall mounted entrance panel that can be easily adapted for two family houses.
An external CCTV colour camera can be directly connected to the entrance panel. Handsfree 7" screen internal unit black finish mirror effect, with touch control commands for main functions.
The system can be expanded up to 3 traditional handsfree internal units.



7" WHITE FINISH EASYKIT ESSENTIAL WITH DIN POWER SUPPLY

One family two wires colour **EASYKIT Essential** video kit with 2-DIN modules power supply and wall mounted entrance panel that can be easily adapted for two family houses.
An external CCTV colour camera can be directly connected to the entrance panel. Handsfree 7" screen internal unit white finish with touch control commands for main functions.
The system can be expanded up to 3 traditional handsfree internal units.





DIN power supply (included)	EASYKIT Wifi with Netatmo	EASYKIT PLUS	EASYKIT ESSENTIAL
	BT-310914 7" inch white finish screen Wifi with Netatmo KIT	BT-318914 7" inch black finish screen Plus KIT	BT-317914 7" inch white finish screen Essential kit
	BT-335254 7" inch white finish additional Wifi with Netatmo Internal unit	BT-334254 7" inch black finish additional Plus Internal unit	BT-333254 7" inch white finish additional Essential Internal unit
Video colour entrance panel 	BT-331860 (Additional colour entrance panel with rainshield)		
Additional External camera 	BT-391441 (European standard PLUG Colour external camera)		
Spare part Power supply 	BT-SP102 (2-DIN Spare part power supply)		



NOTE: internal units are all compatible. As additional internal unit you can use any of the range.

BTICINO BRAND KITS

EASYKIT with DIN POWER SUPPLY



BT-310914



BT-318914



BT-317914



BT-335254



BT-334254



BT-333254

Item **7" White finish EASYKIT Wifi with DIN power supply**

BT-310914 One family two wires colour **EASYKIT Wifi connected video kit with DIN power supply and wall mounted entrance panel.** Metal finish entrance panel with rainshield, colour wide angle camera and LED for the night illumination of the field of view. Entrance panel can be easily adapted for two family houses. An external CCTV colour camera can be directly connected to the entrance panel.

Wifi connected handsfree 7" screen internal unit white finish with 2 DIN modules power supply included. The system can be expanded up to 3 traditional handsfree internal units.

Thanks to the Wifi connection, you can associate the video internal unit to the Home + Security App (available for Android and iOS). You can manage by the App the main video internal unit functions (receiving calls, opening the door lock, view the cameras). Through the same App, it is also possible to manage the products of the Netatmo security range (outdoor and indoor cameras, door and window sensors, indoor siren and smoke detector). This allows you to quickly and easily create a Smart security system.

Additional video internal units

BT-335254 **Additional EASYKIT Wifi connected handsfree 7" screen internal unit in white finish.** Touch control commands for main functions. Wall mounting installation. Thanks to the Wifi connection, you can associate the video internal unit to the Home + Security App (available for Android and iOS).

BT-334254 **Additional EASYKIT Plus handsfree 7" screen internal unit black finish mirror effect.** Touch control commands for main functions. Wall mounting installation.

BT-333254 **Additional handsfree 7" EASYKIT Essential screen internal unit white finish.** Touch control commands for main functions. Wall mounting installation.

Item **7" Mirror black finish EASYKIT Plus with DIN power supply**

BT-318914 One family two wires colour **EASYKIT Plus video kit with DIN power supply and wall mounted entrance panel.** Metal finish entrance panel with rainshield, colour wide angle camera and LED for the night illumination of the field of view. Entrance panel can be easily adapted for two family houses. An external CCTV colour camera can be directly connected to the entrance panel.

Handsfree 7" screen internal unit black finish mirror effect, with touch control commands for main functions and DIN power supply included. The system can be expanded up to 6 internal units (3 per entrance panel) and up to 2 entrance panels.

7" Mirror black finish EASYKIT Essential with DIN power supply

BT-317914 One family two wires colour **EASYKIT Essential video kit with DIN power supply and wall mounted entrance panel.** Metal finish entrance panel with rainshield, colour wide angle camera and LED for the night illumination of the field of view. Entrance panel can be easily adapted for two family houses. An external CCTV colour camera can be directly connected to the entrance panel.

Handsfree 7" screen internal unit white finish with touch control commands for main functions and DIN power supply included. The system can be expanded up to 6 internal units (3 per entrance panel) and up to 2 entrance panels.



BT-331860



BT-391441



BT-SP102

Wiring diagram example

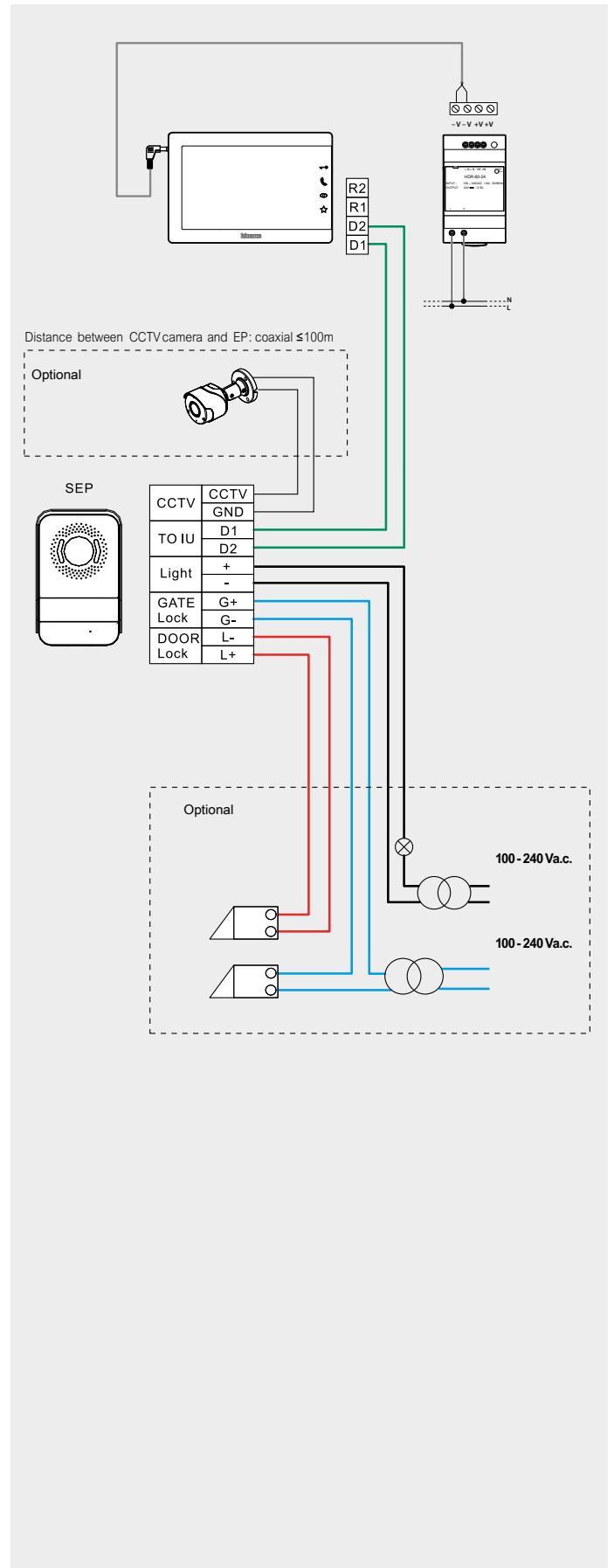

Item Additional video entrance panel with rainshield

BT-331860 Additional video colour entrance panel with rainshield. Wide angle colour camera (105°). IP54 Protection degree.

Additional external camera

BT-391441 Additional external colour camera with coaxial video output, metal case and 3.6 mm fixed lens. Night vision. Power supply 100-240 Vac / 50-60 Hz (12 VDC Plug-in power supply with EU standard socket supplied). Degree of protection IP66 – degree of robustness IK07. Can be connected directly to the entrance panel.

Plug-In power supply

BT-SP102 2 DIN module power supply. Nominal input voltage : 85 - 264 Vac @ 50/60 Hz. Output: 24 Vdc - 2.5 A. It must only be installed indoors and only in switchboards set up for DIN devices. Use an omnipolar switch with separation between the contacts of at least 3 mm positioned near the power supply.

EASYKIT

WITH PLUG-IN POWER SUPPLY

2 WIRES



7" WHITE FINISH **EASYKIT Wifi with Netatmo** WITH PLUG-IN POWER SUPPLY

One family two wires colour **EASYKIT Wifi with Netatmo** connected video kit with plug-in power supply and wall mounted entrance panel that can be easily adapted for two family houses. An external CCTV colour camera can be directly connected to the entrance panel. Wifi connected handsfree 7" screen internal unit white finish with European Plug-In power supply included. The system can be expanded up to 3 traditional handsfree internal units. Thanks to the Wifi connection, you can associate the video internal unit to the HOME + SECURITY App (available for Android and iOS).

You can manage by the App the main video internal unit functions (receiving calls, opening the door lock, view the cameras). Through the same App, it is also possible to manage the products of the Netatmo security range (outdoor and indoor cameras, door and window sensors, indoor siren and smoke detector).

This allows you to quickly and easily create a Smart security system.



7" MIRROR BLACK FINISH **EASYKIT PLUS** WITH PLUG-IN POWER SUPPLY

One family two wires colour **EASYKIT Plus** video kit with plug-in power supply and wall mounted entrance panel that can be easily adapted for two family houses.

An external CCTV colour camera can be directly connected to the entrance panel. Handsfree 7" screen internal unit black finish mirror effect, with touch control commands for main functions and European Plug-In power supply included.

The system can be expanded up to 3 traditional handsfree internal units.







7" WHITE FINISH **EASYKIT ESSENTIAL** WITH PLUG-IN POWER SUPPLY

One family two wires colour **EASYKIT Essential** video kit with plug-in power supply and wall mounted entrance panel that can be easily adapted for two family houses. An external CCTV colour camera can be directly connected to the entrance panel. Handsfree 7" screen internal unit white finish with touch control commands for main functions and European Plug-In power supply included.

The system can be expanded up to 3 traditional handsfree internal units.





PLUG-IN PWS (included)	EASYKIT Wifi with Netatmo	EASYKIT PLUS	EASYKIT ESSENTIAL
European standard 	LG-360910 7 inch white finish screen Wifi with Netatmo KIT	LG-368910 7 inch black finish screen Plus KIT	LG-367910 7 inch white finish screen Essential kit
	LG-365220 7 inch white finish additional Wifi with Netatmo Internal unit	LG-364220 7 inch black finish additional Plus Internal unit	LG-363220 7 inch white finish additional Essential Internal unit
Video colour entrance panel 	LG-369339 (Additional colour entrance panel with rainshield)		
Additional External camera 	LG-369401 (European standard PLUG Colour external camera)		
Spare part Power supply 	BT-SP101 (Spare part plug-in power supply)		

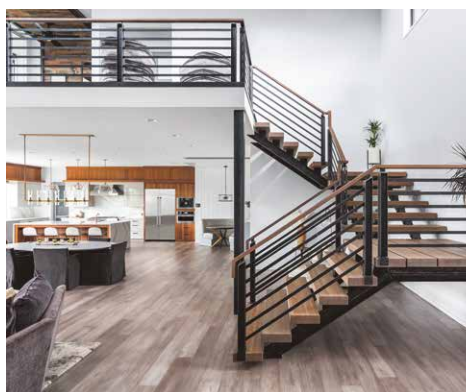

NOTE: internal units are all compatible. As additional internal unit you can use any of the range.

LEGRAND BRAND KITS

EASYKIT with PLUG-IN POWER SUPPLY



LG-360910



LG-368910



LG-367910



LG-365220



LG-364220



LG-363220

Item **7" White finish EASYKIT Wifi with plug-in power supply**

LG-360910 One family two wires colour **EASYKIT Wifi connected video kit with plug-in power supply and wall mounted entrance panel**. Metal finish entrance panel with rainshield, colour wide angle camera and LED for the night illumination of the field of view. Entrance panel can be easily adapted for two family houses. An external CCTV colour camera can be directly connected to the entrance panel.

Wifi connected handsfree 7" screen internal unit white finish with European PLUG-IN std power supply included. The system can be expanded up to 3 traditional handsfree internal units.

Thanks to the Wifi connection, you can associate the video internal unit to the Home + Security App (available for Android and iOS). You can manage by the App the main video internal unit functions (receiving calls, opening the door lock, view the cameras). Through the same App, it is also possible to manage the products of the Netatmo security range (outdoor and indoor cameras, door and window sensors, indoor siren and smoke detector). This allows you to quickly and easily create a Smart security system.

Additional video internal units

LG-365220 **Additional EASYKIT Wifi connected handsfree 7" screen internal unit white finish** with EU standard plug-in power supply included. Touch control commands for main functions. Wall mounting installation. Thanks to the Wifi connection, you can associate the video internal unit to the Home + Security App (available for Android and iOS).

LG-364220 **Additional EASYKIT Plus handsfree 7" screen internal unit black finish mirror effect** with EU standard plug-in power supply included. Touch control commands for main functions. Wall mounting installation.

LG-363220 **Additional handsfree 7" EASYKIT Essential screen internal unit white finish** with EU standard plug-in power supply included. Touch control commands for main functions. Wall mounting installation.

Item **7" Mirror black finish EASYKIT Plus with plug-in power supply**

LG-368910 One family two wires colour **EASYKIT Plus video kit with plug-in power supply and wall mounted entrance panel**. Metal finish entrance panel with rainshield, colour wide angle camera and LED for the night illumination of the field of view. Entrance panel can be easily adapted for two family houses. An external CCTV colour camera can be directly connected to the entrance panel.

Handsfree 7" screen internal unit black finish mirror effect, with touch control commands for main functions and European PLUG-IN std power supply included. The system can be expanded up to 6 internal units (3 per entrance panel) and up to 2 entrance panels.

7" Mirror black finish EASYKIT Essential with plug-in power supply

LG-367910 One family two wires colour **EASYKIT Essential video kit with plug-in power supply and wall mounted entrance panel**. Metal finish entrance panel with rainshield, colour wide angle camera and LED for the night illumination of the field of view. Entrance panel can be easily adapted for two family houses. An external CCTV colour camera can be directly connected to the entrance panel.

Handsfree 7" screen internal unit white finish with touch control commands for main functions and European PLUG-IN std power supply included. The system can be expanded up to 6 internal units (3 per entrance panel) and up to 2 entrance panels.



LG-369339



LG-369401



BT-SP101

Wiring diagram example

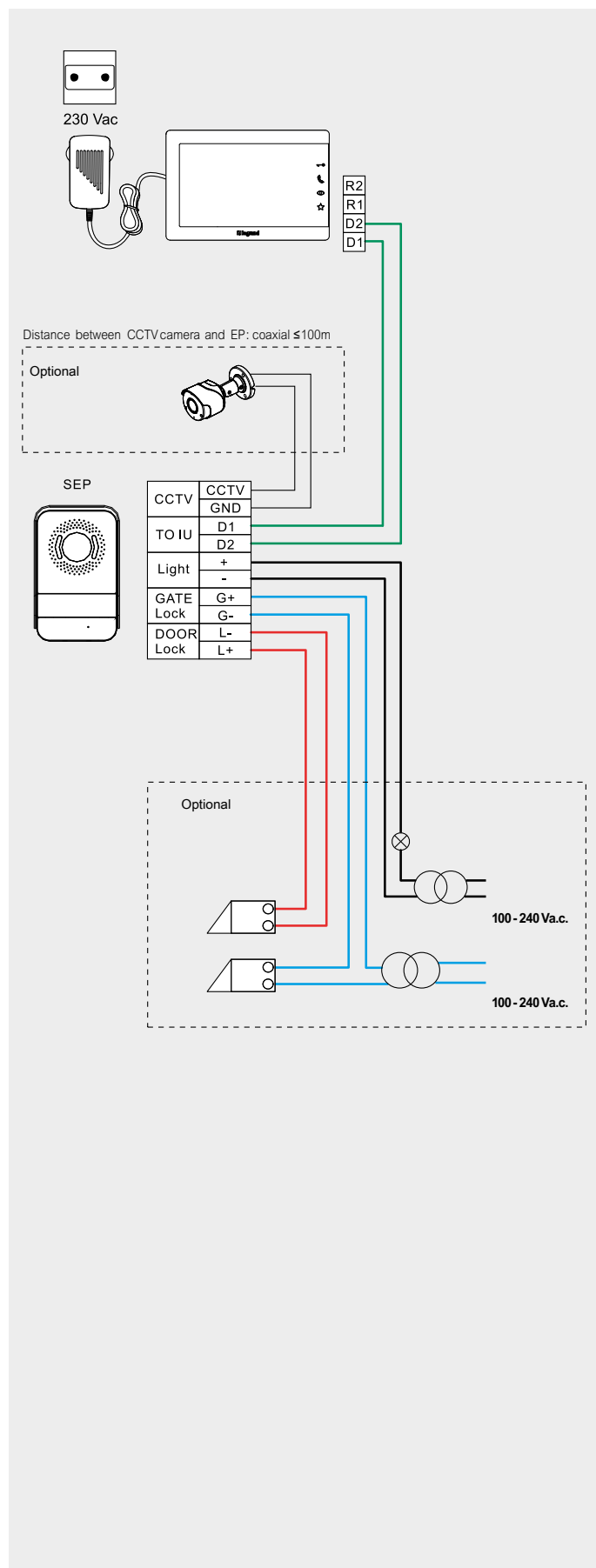

- Item** **Additional video entrance panel with rainshield**
 LG-369339 Additional video colour entrance panel with rainshield. Wide angle colour camera (105°). IP54 Protection degree.
- Additional external camera**
 LG-369401 Additional external colour camera with coaxial video output, metal case and 3.6 mm fixed lens. Night vision. Power supply 100-240 Vac / 50-60 Hz (12 VDC Plug-in power supply with EU standard socket supplied). Degree of protection IP66 – degree of robustness IK07. Can be connected directly to the entrance panel.
- Plug-In power supply**
 BT-SP101 Plug-In power supply with EU Standard plug. Nominal input voltage : 110 - 240 Vac @ 50/60 Hz. Output : 30 Vdc - 1 A. Integrated fuse on PRI side (F1 T2A 250 V).

EASYKIT

WITH DIN POWER SUPPLY

2 WIRES



7" WHITE FINISH **EASYKIT Wifi with Netatmo** WITH DIN POWER SUPPLY

One family two wires colour **EASYKIT Wifi with Netatmo** connected video kit with 2-DIN modules power supply and wall mounted entrance panel that can be easily adapted for two family houses. An external CCTV colour camera can be directly connected to the entrance panel.

Wifi connected handsfree 7" screen internal unit white finish.

The system can be expanded up to 3 traditional handsfree internal units.

Thanks to the Wifi connection, you can associate the video internal unit to the HOME + SECURITY App (available for Android and iOS). You can manage by the App the main video internal unit functions (receiving calls, opening the door lock, view the cameras). Through the same App, it is also possible to manage the products of the Netatmo security range (outdoor and indoor cameras, door and window sensors, indoor siren and smoke detector).

This allows you to quickly and easily create a Smart security system.



7" MIRROR BLACK FINISH **EASYKIT PLUS** WITH DIN POWER SUPPLY

One family two wires colour **EASYKIT Plus** video kit with 2-DIN modules power supply and wall mounted entrance panel that can be easily adapted for two family houses. An external CCTV colour camera can be directly connected to the entrance panel. Handsfree 7" screen internal unit black finish mirror effect, with touch control commands for main functions.

The system can be expanded up to 3 traditional handsfree internal units.



7" WHITE FINISH **EASYKIT ESSENTIAL** WITH DIN POWER SUPPLY

One family two wires colour **EASYKIT Essential** video kit with 2-DIN modules power supply and wall mounted entrance panel that can be easily adapted for two family houses. An external CCTV colour camera can be directly connected to the entrance panel. Handsfree 7" screen internal unit white finish with touch control commands for main functions.

The system can be expanded up to 3 traditional handsfree internal units.





DIN power supply (included)	EASYKIT Wifi with Netatmo	EASYKIT PLUS	EASYKIT ESSENTIAL
	LG-360915 7" inch white finish screen Wifi with Netatmo KIT	LG-368915 7" inch black finish screen Plus KIT	LG-367915 7" inch white finish screen Essential kit
	LG-365225 7" inch white finish additional Wifi with Netatmo Internal unit	LG-364225 7" inch black finish additional Plus Internal unit	LG-363225 7" inch white finish additional Essential Internal unit
Video colour entrance panel 	LG-369339 (Additional colour entrance panel with rainshield)		
Additional External camera 	LG-369401 (European standard PLUG Colour external camera)		
Spare part Power supply 	BT-SP102 (2-DIN Spare part power supply)		



NOTE: internal units are all compatible. As additional internal unit you can use any of the range.

LEGRAND BRAND KITS

EASYKIT with DIN POWER SUPPLY



LG-360915



LG-368915



LG-367915



LG-365225



LG-364225



LG-363225

Item **7" White finish EASYKIT Wifi with DIN power supply**

LG-360915 One family two wires colour **EASYKIT Wifi connected video kit with DIN power supply and wall mounted entrance panel.** Metal finish entrance panel with rainshield, colour wide angle camera and LED for the night illumination of the field of view. Entrance panel can be easily adapted for two family houses. An external CCTV colour camera can be directly connected to the entrance panel.

Wifi connected handsfree 7" screen internal unit white finish with 2 DIN modules power supply included. The system can be expanded up to 3 traditional handsfree internal units.

Thanks to the Wifi connection, you can associate the video internal unit to the Home + Security App (available for Android and iOS). You can manage by the App the main video internal unit functions (receiving calls, opening the door lock, view the cameras). Through the same App, it is also possible to manage the products of the Netatmo security range (outdoor and indoor cameras, door and window sensors, indoor siren and smoke detector). This allows you to quickly and easily create a Smart security system.

Additional video internal units

LG-365225 **Additional EASYKIT Wifi connected handsfree 7" screen internal unit in white finish.** Touch control commands for main functions. Wall mounting installation. Thanks to the Wifi connection, you can associate the video internal unit to the Home + Security App (available for Android and iOS).

LG-364225 **Additional EASYKIT Plus handsfree 7" screen internal unit black finish mirror effect.** Touch control commands for main functions. Wall mounting installation.

LG-363225 **Additional handsfree 7" EASYKIT Essential screen internal unit white finish.** Touch control commands for main functions. Wall mounting installation.

Item **7" Mirror black finish EASYKIT Plus with DIN power supply**

LG-368915 One family two wires colour **EASYKIT Plus video kit with DIN power supply and wall mounted entrance panel.** Metal finish entrance panel with rainshield, colour wide angle camera and LED for the night illumination of the field of view. Entrance panel can be easily adapted for two family houses. An external CCTV colour camera can be directly connected to the entrance panel.

Handsfree 7" screen internal unit black finish mirror effect, with touch control commands for main functions and DIN power supply included. The system can be expanded up to 6 internal units (3 per entrance panel) and up to 2 entrance panels.

Item **7" Mirror black finish EASYKIT Essential with DIN power supply**

LG-367915 One family two wires colour **EASYKIT Essential video kit with DIN power supply and wall mounted entrance panel.** Metal finish entrance panel with rainshield, colour wide angle camera and LED for the night illumination of the field of view. Entrance panel can be easily adapted for two family houses. An external CCTV colour camera can be directly connected to the entrance panel.

Handsfree 7" screen internal unit white finish with touch control commands for main functions and DIN power supply included. The system can be expanded up to 6 internal units (3 per entrance panel) and up to 2 entrance panels.



LG-369339



LG-369401



BT-SP102

Wiring diagram example

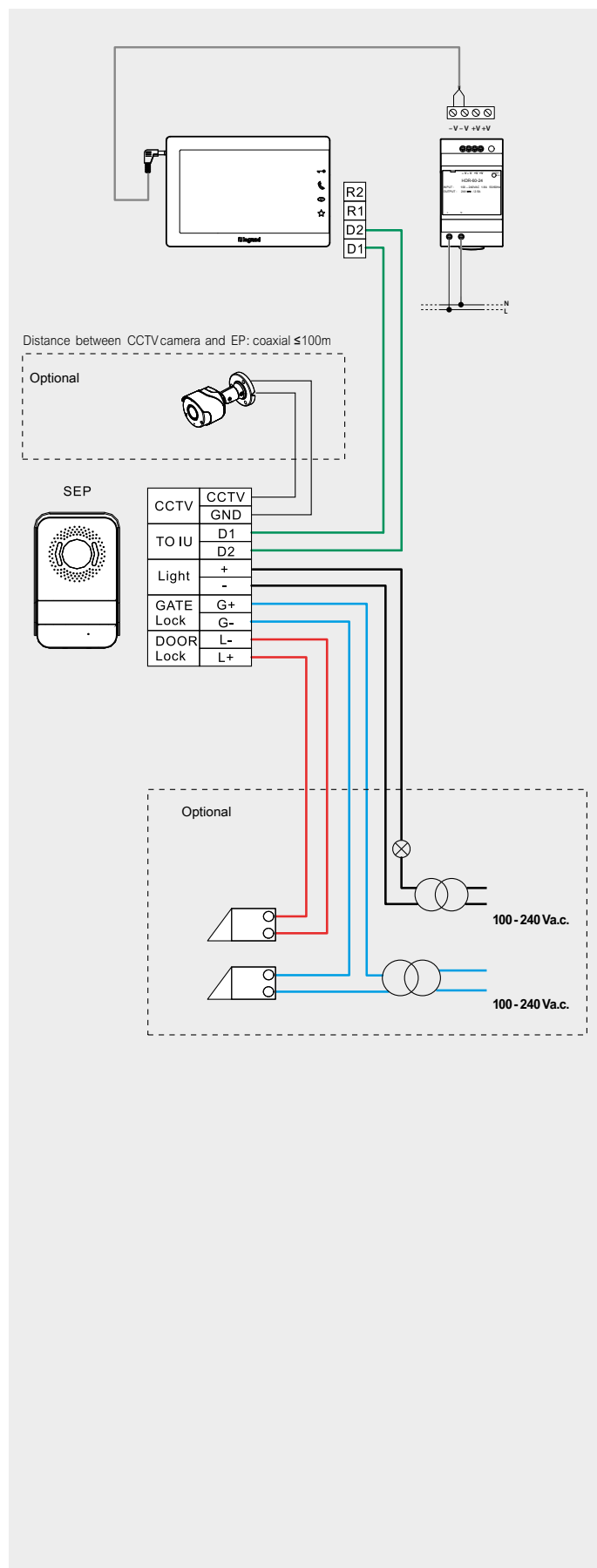

- Item** **Additional video entrance panel with rainshield**
- LG-369339** Additional video colour entrance panel with rainshield. Wide angle colour camera (105°). IP54 Protection degree.
- Additional external camera**
- BT-369401** Additional external colour camera with coaxial video output, metal case and 3.6 mm fixed lens. Night vision. Power supply 100-240 Vac / 50-60 Hz (12 VDC Plug-in power supply with EU standard socket supplied). Degree of protection IP66 – degree of robustness IK07. Can be connected directly to the entrance panel.
- Plug-In power supply**
- BT-SP102** 2 DIN module power supply. Nominal input voltage : 85 - 264 Vac @ 50/60 Hz. Output: 24 Vdc - 2.5 A. It must only be installed indoors and only in switchboards set up for DIN devices. Use an omnipolar switch with separation between the contacts of at least 3 mm positioned near the power supply.

WIRING DIAGRAM EXAMPLES

2 WIRES

Example 1 - SINGLE FAMILY SYSTEM WITH ONE ENTRANCE PANEL & PLUG-IN POWER SUPPLY

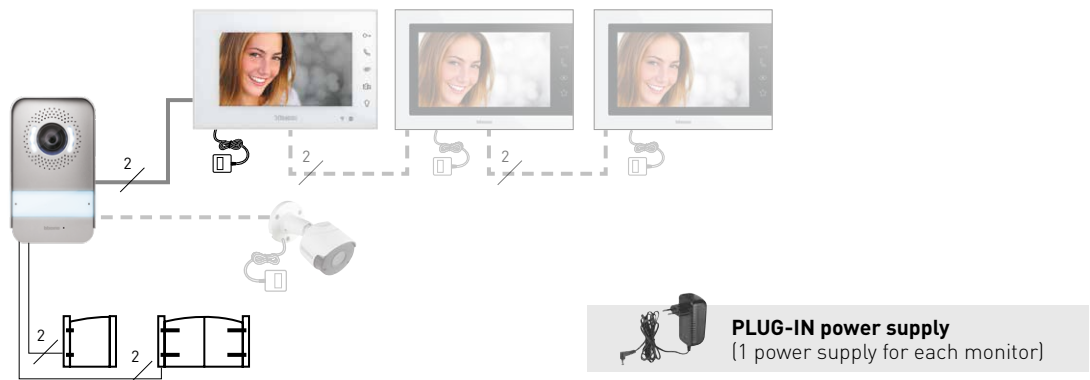

Example 2 - SINGLE FAMILY SYSTEM WITH TWO ENTRANCE PANELS & DIN POWER SUPPLY

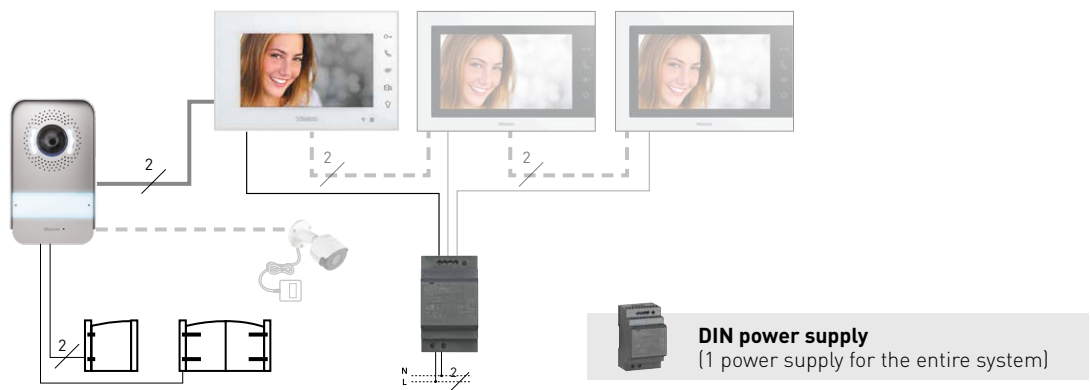

Example 3 - TWO-FAMILY SYSTEM WITH PLUG-IN POWER SUPPLY

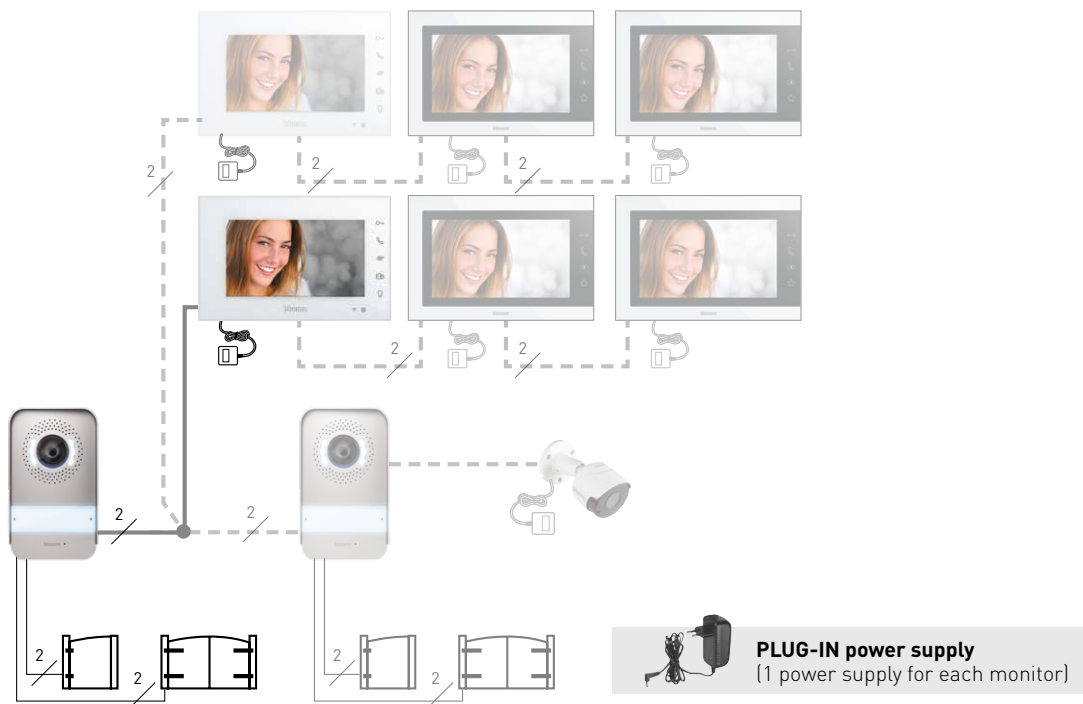

NOTE: if necessary, to control the electrical door lock release, use DIN transformer BT-336842 (230 Va.c.)

Example 4 - TWO-FAMILY SYSTEM WITH DIN POWER SUPPLY

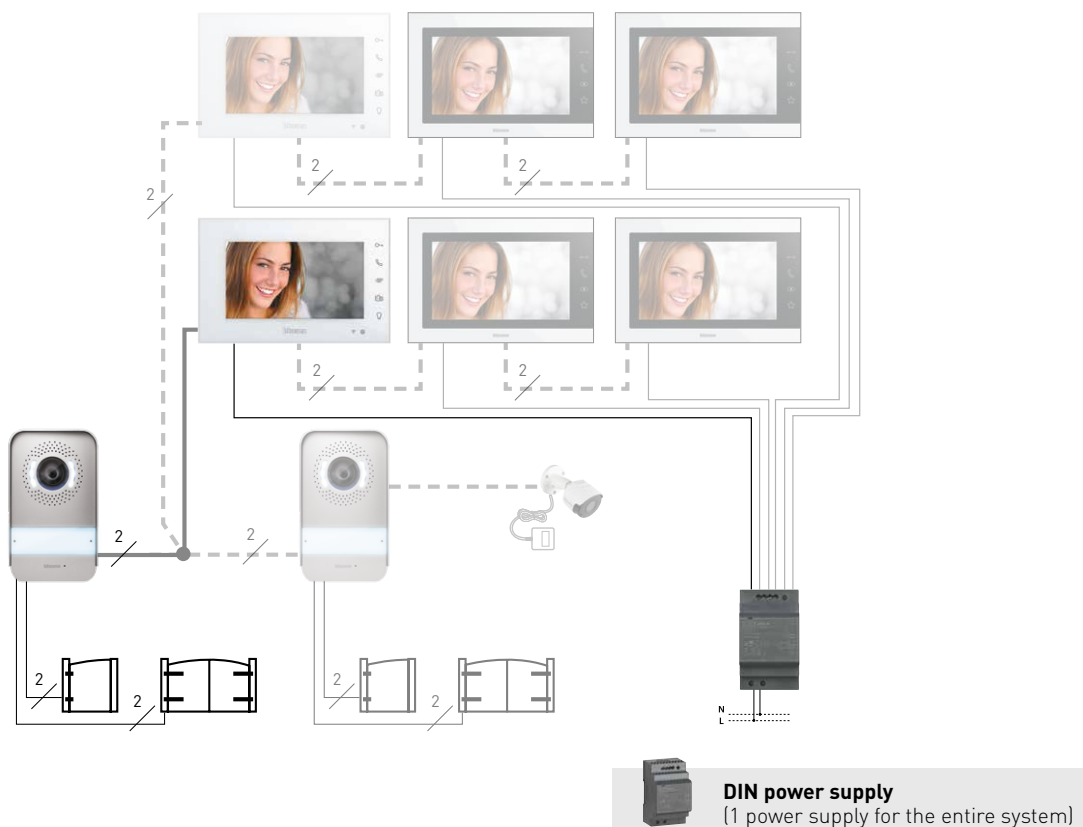

NOTE: if necessary, to control the electrical door lock release, use DIN transformer BT-336842 (230 Va.c.)

BTICINO BRAND KITS



BASIC 4 WIRES

7" COLOUR VIDEO KITS

7" HANDS-FREE AND HANDSET VIDEO KITS

One-family 4-wires colour video **hands-free and handset kits**, wall mounted with internal power supply, expandable up to 4 additional internal units and up to 1 additional entrance panel or a CCTV camera, offering the basic door entry system functions: call, intercom, door lock activation, image cycling. Composed of a hands-free or handset internal unit, with a 7" colour display and 12 ringtones, signaling LED and MUTE function; and a discrete Zamak entrance panel with rain-shield, microphone and speaker volume adjustments, colour camera and LED for enhancing lighting in the visual field.



4.3" COLOUR VIDEO KITS

4.3" HANDS-FREE AND HANDSET VIDEO KITS

One-family 4-wires colour video **hands-free and handset kits**, wall mounted with internal power supply, expandable up to 4 additional internal units and up to 1 additional entrance panel or a CCTV camera, offering the basic door entry system functions: call, intercom, door lock activation, image cycling. Composed of a hands-free or handset internal unit, with a 4.3" colour display and 12 ringtones, signaling LED and MUTE function; and a discrete Zamak entrance panel with rain-shield, microphone and speaker volume adjustments, colour camera and LED for enhancing lighting in the visual field.





HANDSET AUDIO KIT

One-family 4-wires handset audio kit, wall mounted with internal power supply, expandable up to 4 additional internal units, offering the basic door entry system functions: call, intercom, door lock activation. Composed of a handset audio internal unit, signaling LED and MUTE function; and a discrete Zamak entrance panel with rain-shield, microphone and speaker volume adjustments.





	7" VIDEO KITS	4.3" VIDEO KITS	AUDIO KIT
Kit 	BT-315511 (7" Hands-free kit) BT-315411 (7" Handset kit)	BT-315311 (4.3" Hands-free kit) BT-315211 (4.3" Handset kit)	BT-315111 (Handset kit)
Additional internal units 	BT-330851 (Additional 7" Handsfree internal unit) BT-330751 (Additional 7" Handset internal unit)	BT-330651 (Additional 4.3" Handsfree internal unit) BT-330551 (Additional 4.3" Handset internal unit)	BT-330451 (Additional audio handset)
NOTE: internal units are all compatible. As additional internal unit you can use any of the range.			
Additional entrance panels 	BT-330560 (Additional video entrance panel with rainshield) BT-330460 (Additional audio entrance panel with rainshield) BT-330660 (Entrance panel angle bracket accessory)		
Additional external cameras 	BT-391441 (Additional external camera – European standard)		

BTICINO BRAND KITS

BASIC KITS



BT-315511



BT-315411



BT-315311



BT-315211



BT-315111

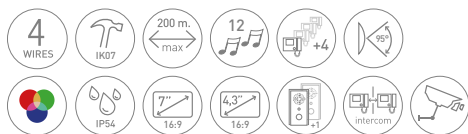

Item **7" Video kits**

ONE-FAMILY 4-wires colour video hands-free or handset kit, wall mounted with internal power supply, expandable up to 4 additional Internal Units and up to 1 additional External Panel or an External Camera (NTSC or PAL), offering the following functions: call, intercom, door lock activation, image cycling. Composed of a hands-free or a handset Video Internal Unit, with a 7" colour display and 12 ringtones, signaling LED and MUTE function; and a discrete Zamak Entrance Panel, with rain-shield, microphone and speaker volume adjustments, colour camera and LED for enhancing lighting in the visual field.

BT-315511 7" Hands-free video kit

BT-315411 7" Handset video kit

4.3" Video kits

ONE-FAMILY 4-wires colour video hands-free or handset kit, wall mounted with internal power supply, expandable up to 4 additional Internal Units and up to 1 additional External Panel or an External Camera (NTSC or PAL), offering the following functions: call, intercom, door lock activation, image cycling. Composed of a hands-free or a handset Video Internal Unit, with a 4.3" colour display, signaling LED and MUTE function; and a discrete Zamak Entrance Panel, with rain-shield, microphone and speaker volume adjustments, colour camera and LED for enhancing lighting in the visual field.

BT-315311 4.3" Hands-free video kit

BT-315211 4.3" Handset video kit

Item **Audio kit**

ONE-FAMILY 3-wires handset Audio kit, wall mounted with internal power supply, expandable up to 4 additional Internal Units, offering the following functions: call, intercom, door lock activation. Composed of a handset Audio Internal Unit, signaling LED and MUTE function; and a discrete Zamak Entrance Panel with rain-shield, microphone and speaker volume adjustments.

BT-315111 Handset audio kit



BT-330851



BT-330751



BT-330651



BT-330551



BT-330451



BT-330560



BT-330460



BT-330660



BT-391441

Item **Additional 7" Video Internal Units**

BT-330851 Colour video hands-free additional Internal Unit, recommended to expand a ONE FAMILY BASIC 4-wires Video Kit, wall mounted with internal power supply, a 7" colour display and 12 ringtones, signaling LED and MUTE function, offering the following functions: call, intercom, door lock activation, image cycling.

BT-330751 Colour video handset additional internal unit, recommended to expand a ONE FAMILY BASIC 4-wires Video Kit, wall mounted with internal power supply, a 7" colour display and 12 ringtones, signaling LED and MUTE function, offering the following functions: call, intercom, door lock activation, image cycling.

Item **Additional 4.3" Video Internal Units**

BT-330651 Colour video hands-free additional Internal Unit, recommended to expand a ONE FAMILY BASIC 4-wires Video Kit, wall mounted with internal power supply, a 4,3" colour display and 12 ringtones, signaling LED and MUTE function, offering the following functions: call, intercom, door lock activation, image cycling.

BT-330551 Colour video handset additional Internal Unit, recommended to expand a ONE FAMILY BASIC 4-wires Video Kit, wall mounted with internal power supply, a 4,3" colour display and 12 ringtones, signaling LED and MUTE function, offering the following functions: call, intercom, door lock activation, image cycling.

Item **Additional Audio handset Internal Unit**

BT-330451 Audio handset additional Internal Unit, recommended to expand ONE FAMILY BASIC Video or Audio Kit, wall mounted with internal power supply, signaling LED and MUTE function, offering the following functions: call, intercom and door lock activation.

Item **Additional Video Entrance Panel**

BT-330560 Additional Zamak Entrance Panel, recommended to expand a ONE FAMILY BASIC 4-wires Video Kit, wall mounted with embedded rain-shield, microphone and speaker volume adjustments, colour camera and LED for enhancing lighting in the visual field.

Item **Additional Audio Entrance Panel**

BT-330460 Additional Zamak Entrance Panel, recommended to expand a ONE FAMILY BASIC Audio or Video Kit, wall mounted with embedded rain-shield, microphone and speaker volume adjustments.

Item **Angle Bracket accessory**

BT-330660 Accessory for the installation of the External Panels **BT-330560 - BT-330460** to adjust its visual field by a 30°-angle, to the right or to the left.

Item **Additional External Camera**

External colour camera, IP66 Protection Degree, PAL video system, with plug-in power supply included.

BT-391441 European standard plug version

BASIC

4 WIRES



7" COLOUR VIDEO KITS

7" HANDS-FREE AND HANDSET VIDEO KITS

One-family 4-wires colour video **hands-free and handset kits**, wall mounted with internal power supply, expandable up to 4 additional internal units and up to 1 additional entrance panel or a CCTV camera, offering the basic door entry system functions: call, intercom, door lock activation, image cycling. Composed of a hands-free or handset internal unit, with a 7" colour display and 12 ringtones, signaling LED and MUTE function; and a discrete Zamak entrance panel with rain-shield, microphone and speaker volume adjustments, colour camera and LED for enhancing lighting in the visual field.



4.3" COLOUR VIDEO KITS

4.3" HANDS-FREE AND HANDSET VIDEO KITS

One-family 4-wires colour video **hands-free and handset kits**, wall mounted with internal power supply, expandable up to 4 additional internal units and up to 1 additional entrance panel or a CCTV camera, offering the basic door entry system functions: call, intercom, door lock activation, image cycling. Composed of a hands-free or handset internal unit, with a 4.3" colour display and 12 ringtones, signaling LED and MUTE function; and a discrete Zamak entrance panel with rain-shield, microphone and speaker volume adjustments, colour camera and LED for enhancing lighting in the visual field.







HANDSET AUDIO KIT

One-family 4-wires handset audio kit, wall mounted with internal power supply, expandable up to 4 additional internal units, offering the basic door entry system functions: call, intercom, door lock activation. Composed of a handset audio internal unit, signaling LED and MUTE function; and a discrete Zamak entrance panel with rain-shield, microphone and speaker volume adjustments.





	7" VIDEO KITS	4.3" VIDEO KITS	AUDIO KIT
Kit 	LG-369580 (7" Hands-free kit) LG-369570 (7" Handset kit)	LG-369560 (4.3" Hands-free kit) LG-369550 (4.3" Handset kit)	LG-369500 (Handset kit)
Additional internal units 	LG-369585 (7" Hands-free additional video internal unit) LG-369575 (7" Handset additional video internal unit)	LG-369565 (4.3" Hands-free additional video internal unit) LG-369555 (4.3" Handset additional video internal unit)	LG-369505 (Handset additional audio internal unit)
NOTE: internal units are all compatible. As additional internal unit you can use any of the range.			
Additional entrance panels 	LG-369596 (Additional video entrance panel with rainshield) LG-369595 (Additional audio entrance panel with rainshield) LG-369597 (Entrance panel angle bracket accessory)		
Additional external cameras 	LG-369401 (Additional external camera – European standard)		



LEGRAND BRAND KITS

BASIC KITS



LG-369580



LG-369570



LG-369560



LG-369550



LG-369500

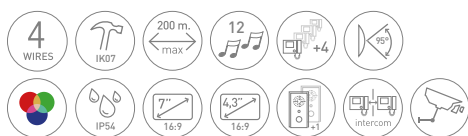

Item **7" Video kits**
 ONE-FAMILY 4-wires colour video hands-free or handset kit, wall mounted with internal power supply, expandable up to 4 additional Internal Units and up to 1 additional External Panel or an External Camera (NTSC or PAL), offering the following functions: call, intercom, door lock activation, image cycling. Composed of a hands-free or a handset Video Internal Unit, with a 7" colour display and 12 ringtones, signaling LED and MUTE function; and a discrete Zamak Entrance Panel, with rain-shield, microphone and speaker volume adjustments, colour camera and LED for enhancing lighting in the visual field.

LG-369580 7" Hands-free video kit

LG-369570 7" Handset video kit

4.3" Video kits
 ONE-FAMILY 4-wires colour video hands-free or handset kit, wall mounted with internal power supply, expandable up to 4 additional Internal Units and up to 1 additional External Panel or an External Camera (NTSC or PAL), offering the following functions: call, intercom, door lock activation, image cycling. Composed of a hands-free or a handset Video Internal Unit, with a 4,3" colour display, signaling LED and MUTE function; and a discrete Zamak Entrance Panel, with rain-shield, microphone and speaker volume adjustments, colour camera and LED for enhancing lighting in the visual field.

LG-369560 4.3" Hands-free video kit

LG-369550 4.3" Handset video kit

Item **Audio kit**
 ONE-FAMILY 3-wires handset Audio kit, wall mounted with internal power supply, expandable up to 4 additional Internal Units, offering the following functions: call, intercom, door lock activation. Composed of a handset Audio Internal Unit, signaling LED and MUTE function; and a discrete Zamak Entrance Panel with rain-shield, microphone and speaker volume adjustments.

LG-369500 Handset audio kit

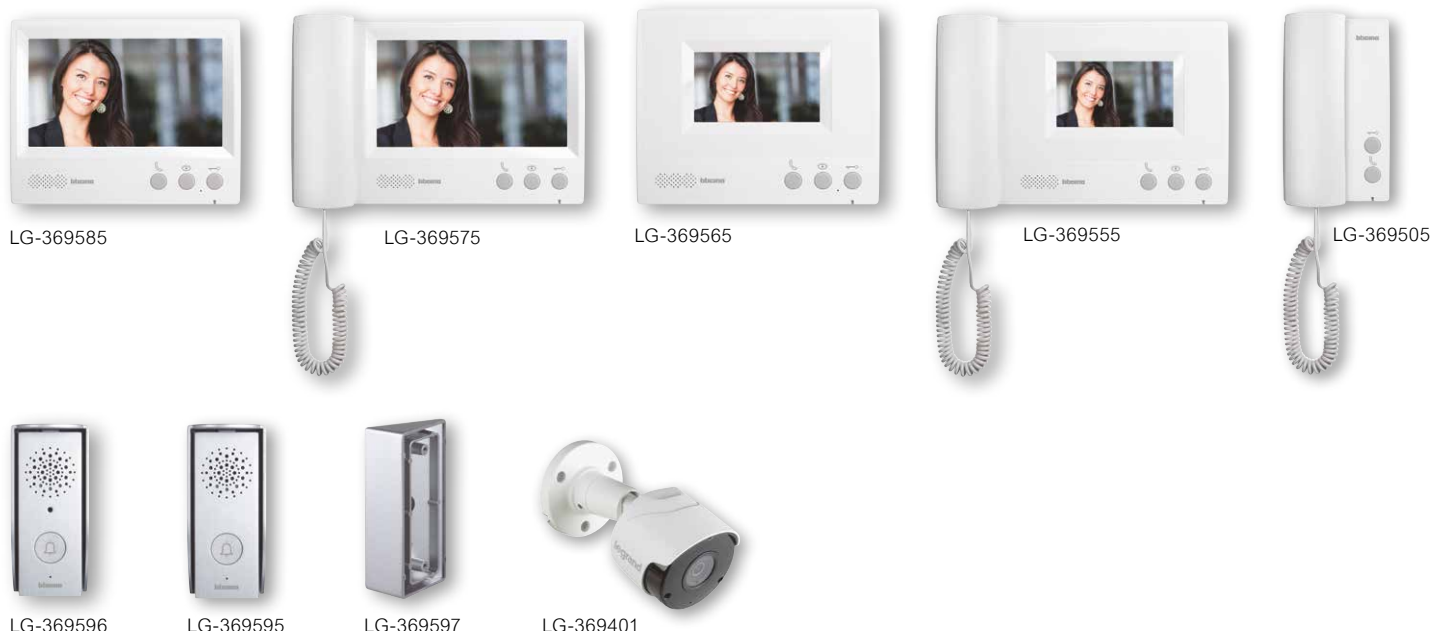

Item Additional 7" Internal Units

- LG-369585 Colour video hands-free additional Internal Unit, recommended to expand a ONE FAMILY BASIC 4-wires Video Kit, wall mounted with internal power supply, a 7" colour display and 12 ringtones, signaling LED and MUTE function, an External Camera (NTSC or PAL), offering the following functions: call, intercom, door lock activation, image cycling.
- LG-369575 Colour video handset additional internal unit, recommended to expand a ONE FAMILY BASIC 4-wires Video Kit, wall mounted with internal power supply, a 7" colour display and 12 ringtones, signaling LED and MUTE function, an External Camera (NTSC or PAL), offering the following functions: call, intercom, door lock activation, image cycling.

Additional 4.3" Internal Units

- LG-369565 Colour video hands-free additional Internal Unit, recommended to expand a ONE FAMILY BASIC 4-wires Video Kit, wall mounted with internal power supply, a 4,3" colour display and 12 ringtones, signaling LED and MUTE function, an External Camera (NTSC or PAL), offering the following functions: call, intercom, door lock activation, image cycling.
- LG-369555 Colour video handset additional Internal Unit, recommended to expand a ONE FAMILY BASIC 4-wires Video Kit, wall mounted with internal power supply, a 4,3" colour display and 12 ringtones, signaling LED and MUTE function, an External Camera (NTSC or PAL), offering the following functions: call, intercom, door lock activation, image cycling.

Additional audio handset Internal Unit

- LG-369505 Audio handset additional Internal Unit, recommended to expand ONE FAMILY BASIC Video or Audio Kit, wall mounted with internal power supply, signaling LED and MUTE function, offering the following functions: call, intercom and door lock activation.

Item Additional video Entrance Panel

- LG-369596 Additional Zamak Entrance Panel, recommended to expand a ONE FAMILY BASIC 4-wires Video Kit, wall mounted with embedded rain-shield, microphone and speaker volume adjustments, colour camera and LED for enhancing lighting in the visual field.

Additional audio Entrance Panel

- LG-369595 Additional Zamak Entrance Panel, recommended to expand a ONE FAMILY BASIC Audio or Video Kit, wall mounted with embedded rain-shield, microphone and speaker volume adjustments

Angle bracket accessory

- LG-369597 Accessory for the installation of the External Panels LG-369596 - LG-369595 to adjust its visual field by a 30°-angle, to the right or to the left.

Additional External Camera

- External colour camera, IP66 Protection Degree, PAL video system, with plug-in power supply included.
- LG-369401 European standard plug version

WIRING DIAGRAM EXAMPLES

4 WIRES

Example 1 - SINGLE FAMILY STANDARD VIDEO SYSTEM

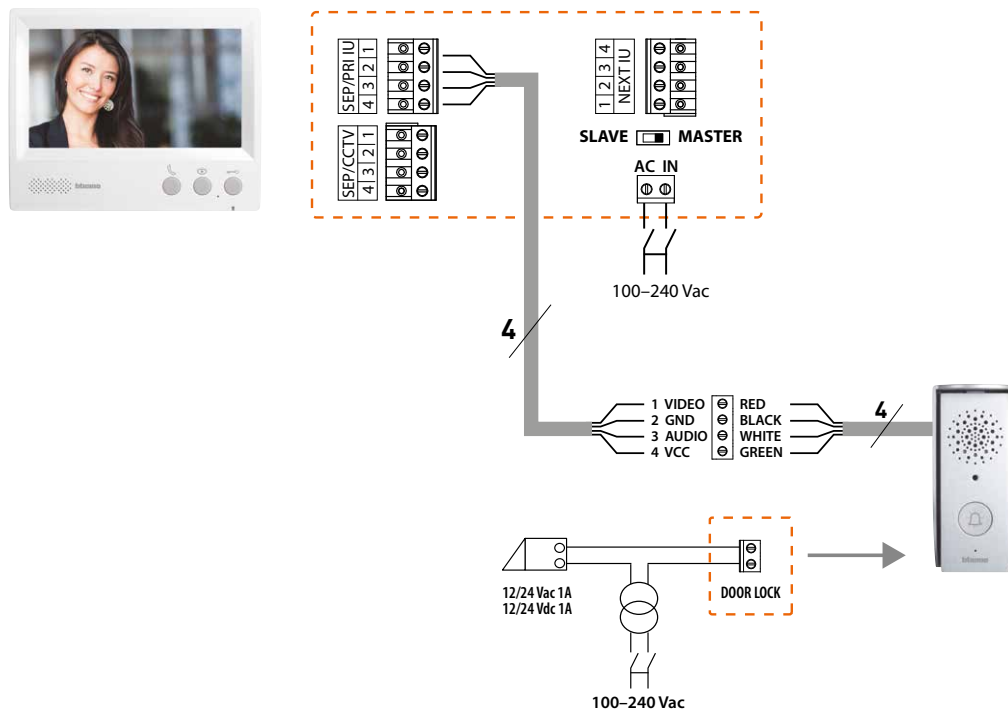

Example 2 - SINGLE FAMILY STANDARD AUDIO SYSTEM

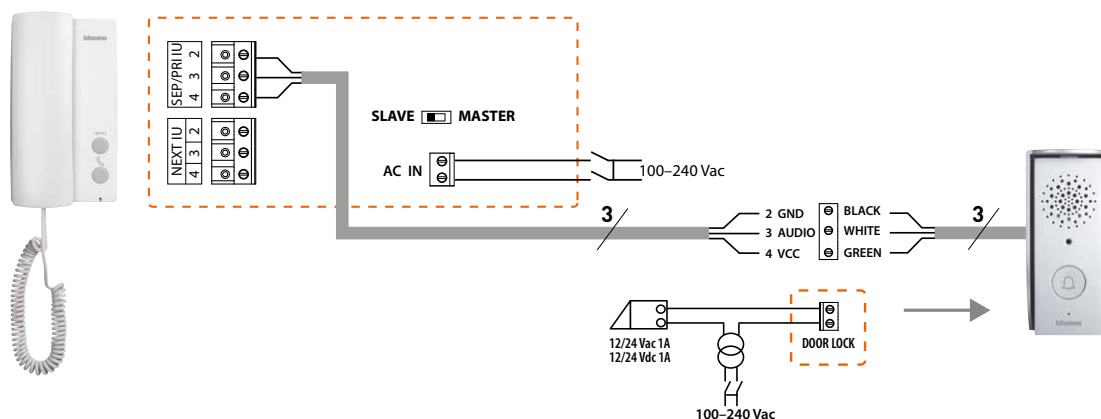

Example 3 - SINGLE FAMILY VIDEO SYSTEM – MAXIMUM EXPANSION WITH CAMERA

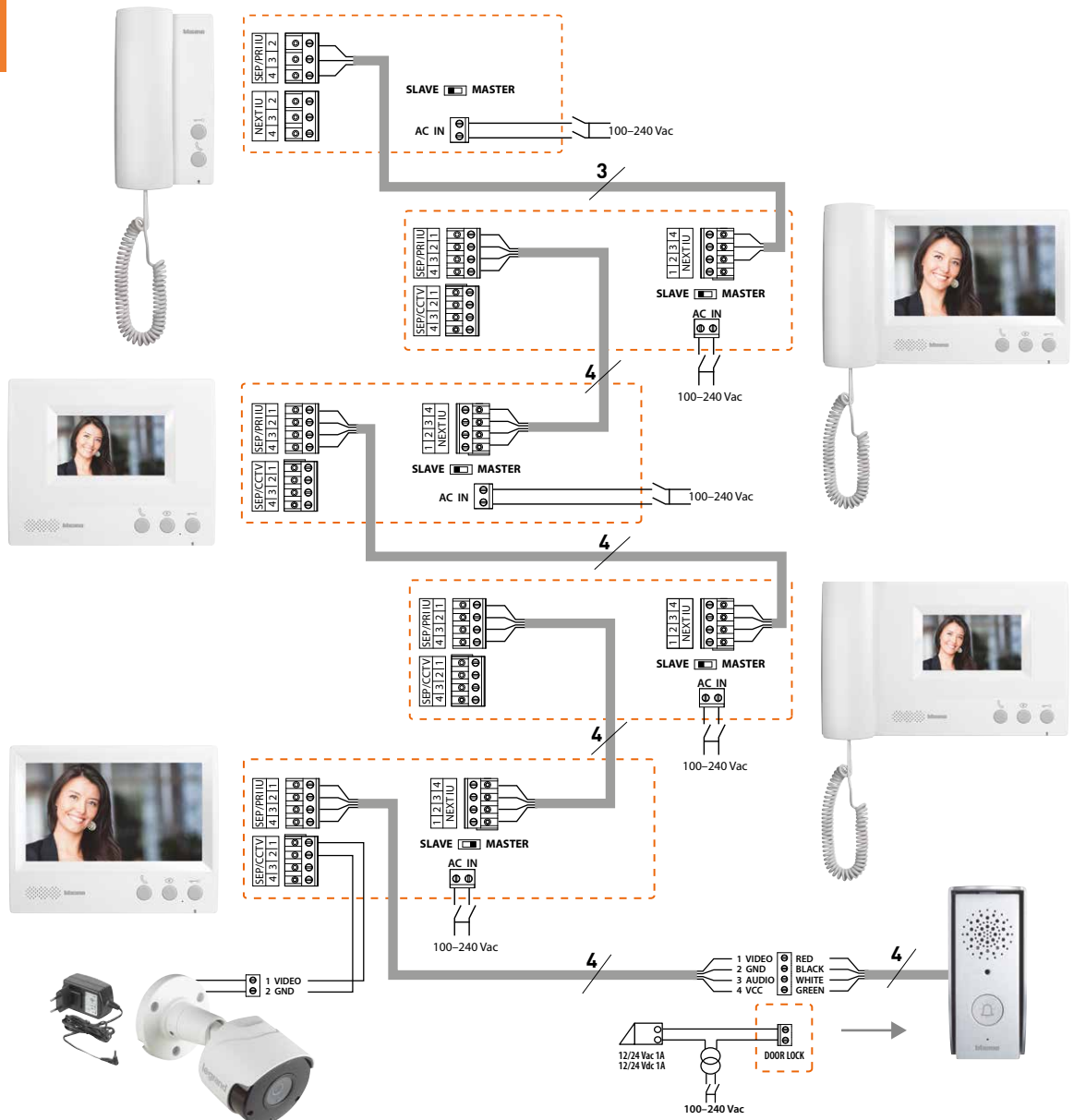

PROFESSIONAL KITS



- The 2-wires technology allows maximum flexibility and expandability
- From basic functions to advanced functions such as call redirection on smartphone, video door entry answering machine, Netatmo cameras integration, intercom and door opening with badge
- Modular DIN-rail power supply
- Include a manual with all the technical information required for the installation, connection, features and expansion possibilities.



SUITABLE FOR VILLA STANDARD - HIGH LEVEL APPLICATIONS



Call redirection
on smartphone



CLASSE 300E0S

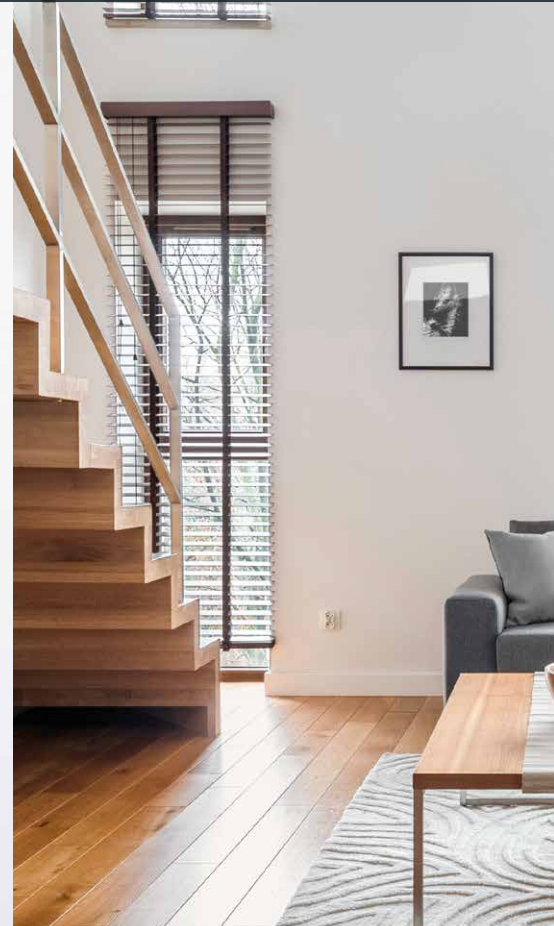

2 WIRES

FULL EXPANDIBILITY

EXPANSION

Expand these kits with other devices such as additional entrance panels, internal units, cameras, and home automation devices.

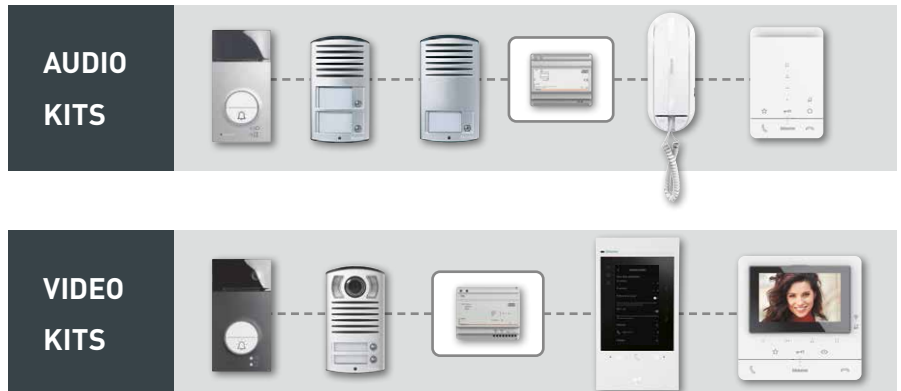

NETATMO
Smart Outdoor camera



LINEA 3000

Door opening with badge



PROFESSIONAL KITS

MAXIMUM SIMPLICITY

The 2 Wires professional kits guarantee maximum simplicity and flexibility of installation. They are the ideal solution for making new systems and in renovations. Both audio and video systems require only 2 WIRES for the installation, so that existing wires can be used in the renovations. There is no need to respect polarity in the connections, giving maximum simplification in the installation work.

LINEA 3000 - One family audio Kit – installation example

ONE
FAMILY HOUSE

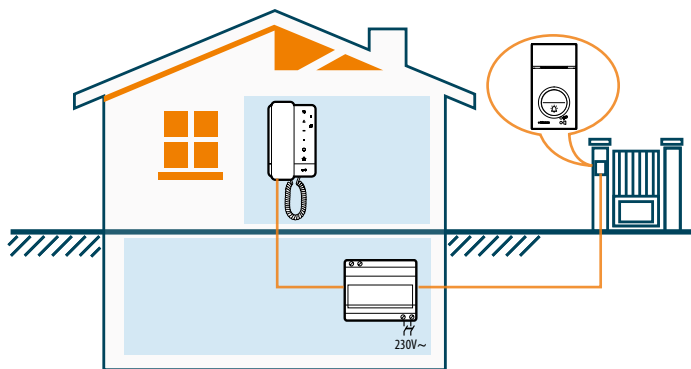

ONE FAMILY AUDIO KIT 364231

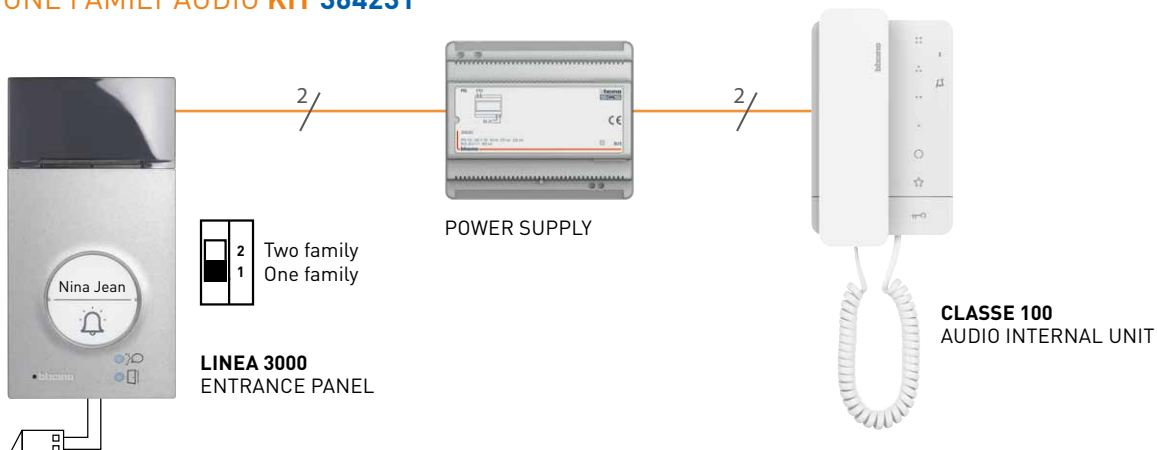

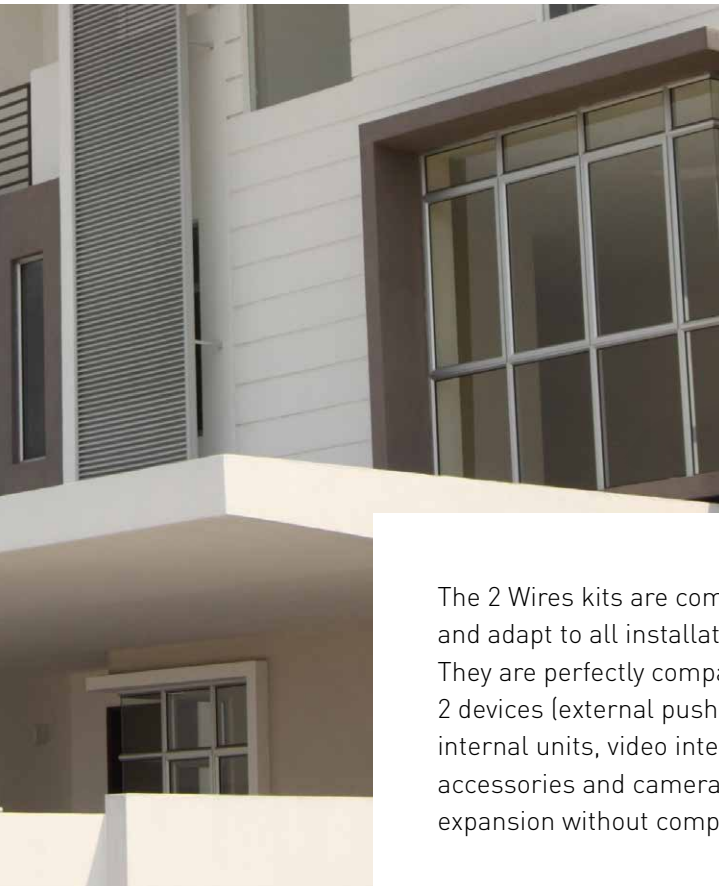

VIDEO KIT

AUDIO KIT

The 2 Wires kits are completely expandable and adapt to all installation needs. They are perfectly compatible with the 2 devices (external pushbutton panels, internal units, video internal units, system accessories and cameras), allowing expansion without compromises.

LINEA 3000 - Two family video Kit – installation example

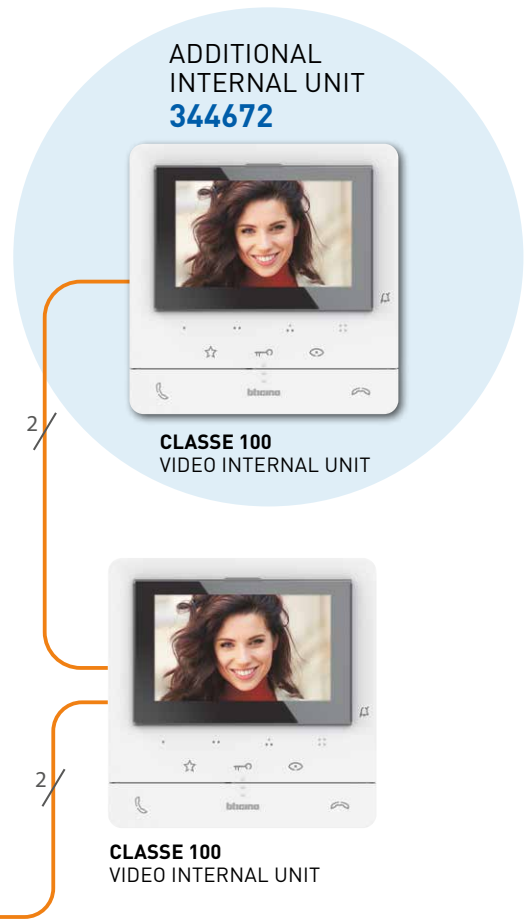
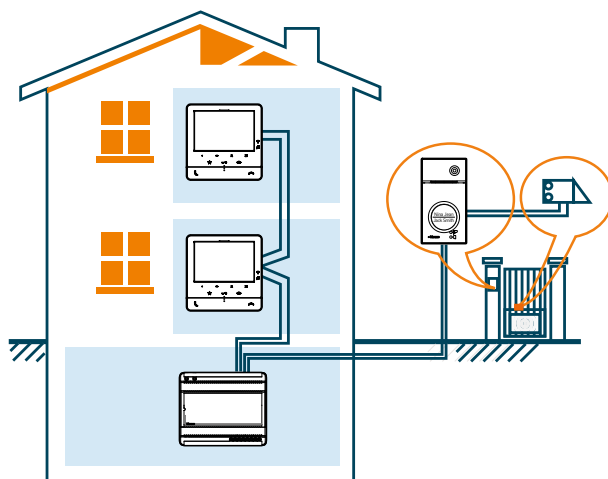

ADDITIONAL INTERNAL UNIT
344672

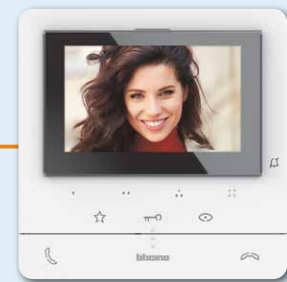

CLASSE 100
VIDEO INTERNAL UNIT



CLASSE 100
VIDEO INTERNAL UNIT

TWO FAMILY VIDEO KIT 364612

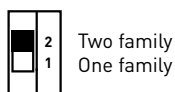

LINEA 3000
ENTRANCE PANEL

POWER SUPPLY



PROFESSIONAL KITS

VILLA CONNECTED VIDEO KITS



363950

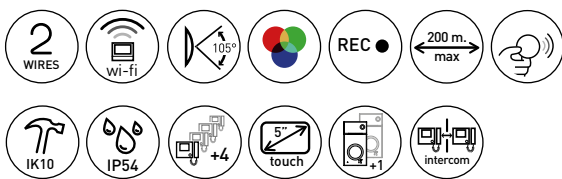
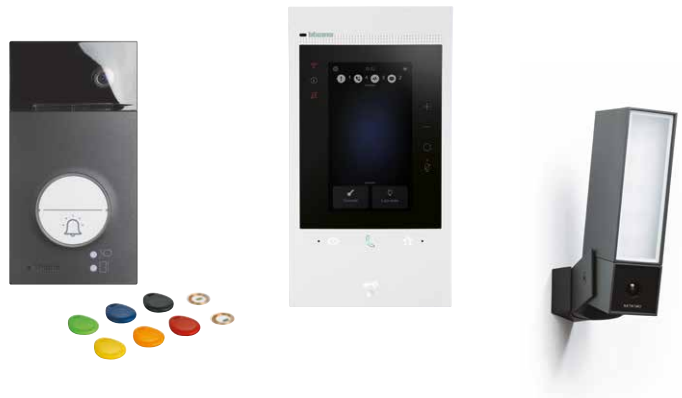

Item

CLASSE 300EOS - LINEA 3000 - Netatmo smart outdoor camera connected kit

One-family kit with Classe 300EOS handsfree connected video internal unit, LINEA 3000 pushbutton panel in black finish and Netatmo Smart Outdoor Camera.

2 wires/Wi-Fi handsfree connected video internal unit with Teleloop, built-in Amazon Alexa voice assistant, 5" vertical touch screen LCD display and video door entry answering machine. Easy interaction with the built-in Alexa voice assistant, either using the dedicated capacitive keys or with your voice, and activate several functions, such as the video door entry functions, Smart Home, scenarios, reminders etc. Thanks to the Wi-Fi connectivity, you can associate the video internal unit to the Home + Security App (available for Android and iOS). The App allows to use the main video internal unit functions (receiving calls, door lock release, display of the event timeline and activation of the entrance panel/camera cycling). With the Home + Security App, it is also possible to manage the products of Netatmo security range (outdoor and indoor cameras, door and window sensors, indoor siren, smoke detector). This allows you to quickly and easily create a Smart security system. The device also allows to create and manage Smart Home functions, using the wired SCS BUS solution or the Zigbee solution, without the need for adding dedicated gateways. LINEA 3000 pushbutton panel with black finish zamak front cover, wide angle colour camera and proximity reader and with a kit of coloured key cards and two clear discs for door lock release. Can be wall or flush installed with specific accessories: (350020) flush mounted box and (343063) flush mounted accessory - to be purchased separately. Can be fitted with rainshield (343053) - to be purchased separately. The pushbutton panel has a protection index IP54- protection index against mechanical impact IK10. Smart Outdoor Security Camera with LED lighting spotlight, night vision and motion detection – send real time notification on smartphone in case of unknown person or vehicle detection.

363950

Complete one family kit

(Easy switch to two families system by purchasing an additional internal unit - refer to 2 Wires system internal units range).

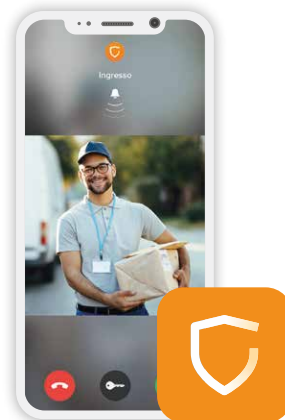

HOME + SECURITY is the App that allows, through the smartphone, to manage calls locally and remotely of the video door phone or with a simple touch to open the gate, the activation of the cameras, and switching on of the timed lights in the garden. Allows you to activate and view images of Netatmo Smart Outdoor and Indoor Cameras. Setting up the App requires a few steps and thanks to the BTicino Cloud, the remote connection is fully automated and managed with the highest level of security.

Item	Kit composition	Qty
343093	LINEA 3000 pushbutton panel	1
344842	CLASSE 300EOS video internal unit	1
NOC-PRO	Smart Outdoor Camera	1
346050	6 DIN SCS power supply	1
346250	Door lock relay accessory	1
348260	Set of coloured door lock release key cards	1
348261	Set of door lock release clear discs	1



363915

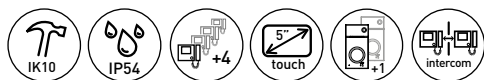

CLASSE 300EOS WITH NETATMO – LINEA 3000 connected video kit

One family handsfree kit with Classe 300EOS with Netatmo handsfree connected video internal unit and LINEA 3000 pushbutton panel in black finish. 2 wires/Wi Fi handsfree connected video internal unit with built in Amazon Alexa voice assistant, 5" vertical touch screen LCD display and video door entry answering machine. It is possible to easily interact with the built in Alexa voice assistant, either using the dedicated capacitive keys or with your voice, and activate several functions, such as the video door entry functions, Smart Home, scenarios, reminders etc. Thanks to the Wi Fi connectivity, you can associate the video internal unit to the Home + Security App (available for Android and iOS). The App allows to use the main video internal unit functions (receiving calls, door lock release, display of the event timeline and activation of the entrance panel/camera cycling). With the Home + Security App, it is also possible to manage the products of the Netatmo security range (outdoor and indoor cameras, door and window sensors, indoor siren, smoke detector). This allows you to quickly and easily create a Smart security system. The device also allows to create and manage MyHOME functions, using the wired SCS BUS solution. LINEA 3000 pushbutton panel with black finish zamak front cover, wide angle colour camera and proximity reader and with a kit of coloured key cards and two clear discs for door lock release. Can be wall or flush installed with specific accessories: (350020) flush mounted box and (343063) flush mounted accessory to be purchased separately. Can be fitted with rainshield (343053) to be purchased separately. The pushbutton panel has a protection index IP54 protection index against mechanical impact IK10.

363915 Complete one family kit

(Easy switch to two families system by purchasing an additional internal unit - refer to 2 Wires system internal units range).



HOME + SECURITY is the App that allows, through the smartphone, to manage calls locally and remotely of the video door phone or with a simple touch to open the gate, the activation of the cameras, and switching on of the timed lights in the garden. Allows you to activate and view images of Netatmo Smart Outdoor and Indoor Cameras. Setting up the App requires a few steps and thanks to the BTicino Cloud, the remote connection is fully automated and managed with the highest level of security.

Item	Kit composition	Qty
343093	LINEA 3000 pushbutton panel	1
344842	CLASSE 300EOS video internal unit (white finish)	1
346050	6 DIN SCS power supply	1
346250	Door lock relay accessory	1
348260	Set of coloured door lock release key cards	1
348261	Set of door lock release clear discs	1

PROFESSIONAL KITS

VILLA CONNECTED VIDEO KITS



363926



344884

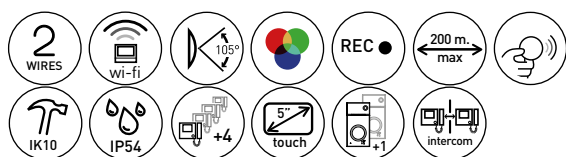

Item **CLASSE 300EOS WITH NETATMO- LINEA 3000 - Connected video Kit**

One-family handsfree kit with Classe 300EOS with Netatmo handsfree connected video internal unit and LINEA 3000 pushbutton panel in black finish. 2 wires/Wi-Fi handsfree connected video internal unit with built-in Amazon Alexa voice assistant, 5" vertical touch screen LCD display and video door entry answering machine. It is possible to easily interact with the built-in Alexa voice assistant, either using the dedicated capacitive keys or with your voice, and activate several functions, such as the video door entry functions, Smart Home, scenarios, reminders etc. Thanks to the Wi-Fi connectivity, you can associate the video internal unit to the Home + Security App (available for Android and iOS). The App allows to use the main video internal unit functions (receiving calls, door lock release, display of the event timeline and activation of the entrance panel/camera cycling). With the Home + Security App, it is also possible to manage the products of the Netatmo security range (outdoor and indoor cameras, door and window sensors, indoor siren, smoke detector). This allows you to quickly and easily create a Smart security system. The device also allows to create and manage MyHOME functions, using the wired SCS BUS solution. LINEA 3000 pushbutton panel with black finish zamak front cover, wide angle colour camera and proximity reader and with a kit of coloured key cards and two clear discs for door lock release. Can be wall or flush installed with specific accessories: (350020) flush mounted box and (343063) flush mounted accessory - to be purchased separately. Can be fitted with rainshield (343053) - to be purchased separately. The pushbutton panel has a protection index IP54-protection index against mechanical impact IK10.

363926 Complete one family kit

(Easy switch to two families system by purchasing an additional internal unit - refer to 2 Wires system internal units range).

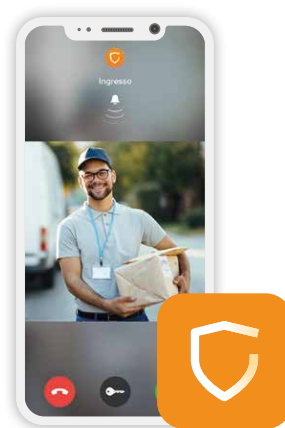

HOME + SECURITY is the App that allows, through the smartphone, to manage calls locally and remotely of the video door phone or with a simple touch to open the gate, the activation of the cameras, and switching on of the timed lights in the garden. Allows you to activate and view images of Netatmo Smart Outdoor and Indoor Cameras. Setting up the App requires a few steps and thanks to the BTicino Cloud, the remote connection is fully automated and managed with the highest level of security.

Item	Kit composition	Qty
343093	LINEA 3000 pushbutton panel	1
344884	CLASSE 300EOS video internal unit (black finish)	1
346050	6 DIN SCS power supply	1
346250	Door lock relay accessory	1
348260	Set of coloured door lock release key cards	1
348261	Set of door lock release clear discs	1



364614

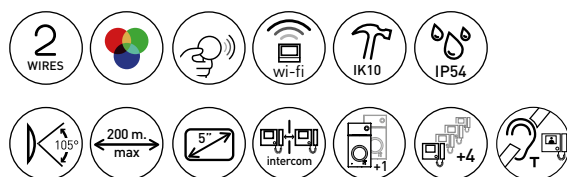

Item CLASSE 100X16E - LINEA 3000 connected video kit

One-family handsfree kit with: Classe 100X16E with Netatmo Wifi video internal unit, handsfree function, inductive loop, 5" LCD display; LINEA 3000 pushbutton panel with zamak front cover, wide angle colour camera, proximity reader and with a set of coloured key cards and two clear discs for door lock release. Can be configured for one-family and two-family installations. Nameplate lit by white LED. Can be wall or flush installed with specific accessories: (350020) flush mounted box and (343061) flush mounted accessory - to be purchased separately. Can be fitted with rainshield (343051)- to be purchased separately. The pushbutton panel has a protection index IP54- protection index against mechanical impact IK10. The video internal unit has 4.3" colour LCD display and Inductive Loop function (to enable use by people wearing hearing aids fitted with T selector). It also has 3 touch keys for the control of the main functions – door lock release, staircase light control and entrance panel activation/scrolling – there are further 4 configurable touch keys that perform different functions – e.g. staircase light control, intercom, additional door lock activation, generic activations. It has a side lever to adjust: colour, brightness and display contrast, audio volume, call tone volume and Wi-Fi configuration. There are call exclusion notification LEDs and Wifi. Also, thanks to the Wifi connection, you can associate the video internal unit to the Home + Security App (available for Android and iOS). Through the Home + Security App it is also possible to manage the products of Netatmo security offer (Outdoor and Indoor cameras, door and window sensors, internal siren and smoke detector). The installation can be made to the wall using the bracket supplied or using table support accessories (2 x 344692) – to be purchased separately. The device, also equipped with the professional studio (office) function, must be configured.

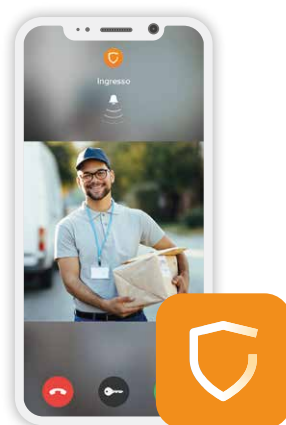

HOME + SECURITY is the App that allows, through the smartphone, to manage calls locally and remotely of the video door phone or with a simple touch to open the gate, the activation of the cameras, and switching on of the timed lights in the garden. Allows you to activate and view images of Netatmo Smart Outdoor and Indoor Cameras. Setting up the App requires a few steps and thanks to the BTicino Cloud, the remote connection is fully automated and managed with the highest level of security.

Item	Kit composition	Qty
343093	LINEA 3000 pushbutton panel	1
344682	CLASSE 100X16E video internal unit	1
346050	6 DIN SCS power supply	1
346250	Door lock relay accessory	1
348260	Set of coloured door lock release key cards	1
348261	Set of door lock release clear discs	1

364614 Complete one family kit

(Easy switch to two families system by purchasing an additional internal unit - refer to 2 Wires system internal units range).

PROFESSIONAL KITS

VILLA VIDEO KITS



364612

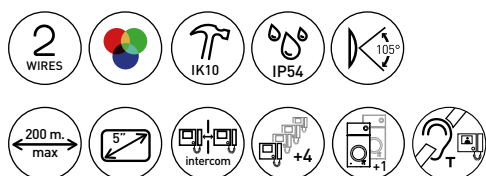

Item **CLASSE 100V16E - LINEA 3000 video kit**

One-family handsfree kit with CLASSE 100V16E video indoor unit and LINEA 3000 pushbutton panel with zamak front cover and wide angle colour camera. Can be configured for one-family or two-family installations. Nameplate lit by white LED. Can be wall or flush installed with specific accessories: (350020) flush mounted box with (343061) flush mounted accessory - to be purchased separately. Can be fitted with rainshield (343051) – to be purchased separately.

The pushbutton panel has a protection index IP54 - protection index against mechanical impact IK10. The video indoor unit has 5" LCD display and Inductive Loop function (to enable use by people wearing hearing aids fitted with T selector). It has 2 physical keys for the control of the main functions – answer and end a call – and has 3 touch keys for the control of the main functions – door lock release, staircase light control and entrance panel activation/scrolling – there are further 4 configurable touch keys that perform different functions – e.g. intercom, additional door lock activation, generic activations. Wall mounted installation with the bracket supplied or table installation with support accessories (2 x 344692) - to be purchased separately.

The device also has Professional Studio (Office) function and must be configured.

364612 **Complete one family kit**

(Easy switch to two families system by purchasing an additional internal unit - refer to 2 Wires system internal units range).

Item	Kit composition	Qty
343081	LINEA 3000 Entrance panel	1
344672	CLASSE 100V16E Video internal unit	1
346050	6 DIN System power supply	1
346250	Relay module accessory	1



364613

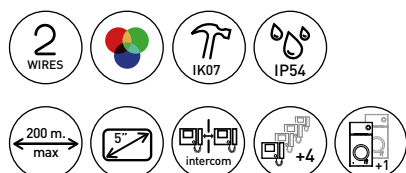

364622

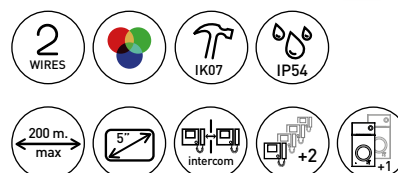

Item 364613 CLASSE 100V16E - LINEA 2000 video kit

One-family handsfree video kit consisting of: CLASSE 100V16B video indoor unit, LINEA 2000 pushbutton panel with colour camera and 1 call pushbutton. The push-button panel has a protection index against mechanical impact IK07 and protection index IP54. The video indoor unit has 2 physical keys for the control of the main video door entry functions – answer and end a call – and 3 touch keys that allow the door lock release, the entrance panel activation/scrolling and the customization of a most frequently used quick action – e.g. staircase light control, intercom, additional door lock activation, generic activations. The video indoor unit has a 5" colour LCD display and a side lever to adjust: colour, brightness and display contrast, audio and call tone volume. There is a call exclusion notification LED. Wall mounted installation with the bracket supplied or table installation with support accessories (2 x 344692) - to be purchased separately.

Item 364622 CLASSE 100V16B - LINEA 2000 video kit

Two-families handsfree video kit consisting of: CLASSE 100V16B video indoor units, LINEA 2000 pushbutton panel with colour camera and 2 call pushbuttons. The push-button panel has a protection index against mechanical impact IK07 and protection index IP54. The video indoor units has 2 physical keys for the control of the main video door entry functions – answer and end a call – and 3 touch keys that allow the door lock release, the entrance panel activation/scrolling and the customization of a most frequently used quick action – e.g. staircase light control, intercom, additional door lock activation, generic activations. The video indoor units has a 5" colour LCD display and a side lever to adjust: colour, brightness and display contrast, audio and call tone volume. There is a call exclusion notification LED. Wall mounted installation with the bracket supplied or table installation with support accessories (2 x 344692) - to be purchased separately.

Item	Kit composition	Qty
343031	LINEA 2000 Entrance panel - 1 CALL	1
344652	CLASSE 100V16B Video internal unit	1
346050	6 DIN System power supply	1
346250	Relay module accessory	1

Item	Kit composition	Qty
343032	LINEA 2000 Entrance panel - 2 CALLS	1
344652	CLASSE 100V16B Video internal unit	2
346050	6 DIN System power supply	1
346250	Relay module accessory	1

PROFESSIONAL KITS

VILLA AUDIO KITS



364232

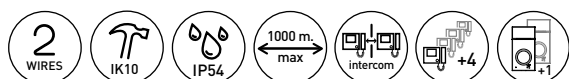

364231

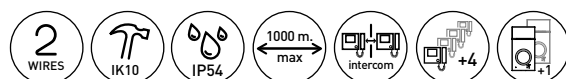

Item **CLASSE 100A16E - LINEA 3000 hands free audio kit**

364232 One-family handsfree kit with CLASSE 100A16E audio indoor unit and LINEA 3000 pushbutton panel with zamak front cover. Can be configured for one-family or two-family installations. Nameplate lit by white LED. Can be wall or flush installed with specific accessories: (350020) flush mounted box with (343061) flush mounted accessory - to be purchased separately. Can be fitted with rainshield (343051) – to be purchased separately. The pushbutton panel has a protection index IP54 – protection index against mechanical impact IK10. The indoor unit has 2 physical keys for the control of the main door entry functions – answer and end a call – and has 3 touch keys for the control of the main functions – door lock release, staircase light control and entrance panel activation/scrolling – there are further 4 configurable touch keys that perform different functions – e.g. intercom, additional door lock activation, generic activations. Ringtone volume adjustment (with call exclusion) using the appropriate selector. The installation can be made to the wall using the bracket supplied or using table support accessory (1 x 344692) – to be purchased separately. The device also has Professional Studio (Office) function and must be configured.

Item **CLASSE 100A16M - LINEA 3000 AUDIO kit with hand set**

364231 One-family audio kit with CLASSE 100A16M audio indoor unit and LINEA 3000 pushbutton panel with zamak front cover. Can be configured for one-family or two-family installations. Nameplate lit by white LED. Can be wall or flush installed with specific accessories: (350020) flush mounted box with (343061) flush mounted accessory – to be purchased separately. Can be fitted with rainshield (343051) – to be purchased separately. The pushbutton panel has a protection index IP54 – protection index against mechanical impact IK10. The audio indoor unit has 3 touch keys for the control of the main functions – door lock release, staircase light control and entrance panel activation/scrolling – there are further 4 configurable touch keys that perform different functions – e.g. intercom, additional door lock activation, generic activations. Ringtone volume adjustment (with call exclusion) using the appropriate selector. The installation can be made to the wall using the bracket supplied or using table support accessory (1 x 344692) – to be purchased separately. The device also has Professional Studio (Office) function and must be configured.

Item	Kit composition	Qty
343071	LINEA 3000 Audio entrance panel	1
344282	CLASSE 100A16E Audio internal unit	1
346040	6 DIN System power supply	1

Item	Kit composition	Qty
343071	LINEA 3000 Audio entrance panel	1
344292	CLASSE 100A16M Audio internal unit	1
346040	6 DIN System power supply	1



366811

366821



Item	SPRINT L2 – LINEA 2000 AUDIO handset audio kit
	Audio kit with audio handset SPRINT L2 and LINEA 2000 pushbutton panel. 2 WIRE technology. The audio handset has a door lock release pushbutton and a pushbutton that can be configured for auxiliary functions (staircase light switching on, entrance panel activation, call to the switchboard). Devices suitable for wall mounted installation. Expandable with additional audio handset 344242 .
366811	Complete one-family kit
366821	Complete two-family kit

Item	Kit composition	366811 Qty	366821 Qty
342911	LINEA 2000 Entrance panel - 1 CALL	1	-
342921	LINEA 2000 Entrance panel - 2 CALLS	-	1
344232	SPRINT L2 audio handset	1	2
346040	6 DIN System power supply	1	1



364211

Item	Audio handsfree - LINEA 2000
364211	One-family expandable audio kit with audio handsfree internal unit and LINEA 2000 pushbutton panel. The audio internal unit can manage with (1 – 2) pushbuttons on board two independent contacts (24 Vac/dc – 1 A max.) Entrance panel and internal unit are suitable for wall mounted installation. Expansion possibility using the specific additional handsfree internal unit 331650

Item	Kit composition	Qty
342911	LINEA 2000 Entrance panel - 1 CALL	1
331650	Audio handsfree internal unit	1
346040	6 DIN System power supply	1

PROFESSIONAL KITS

ANALOGUE KITS

Audio Kits



363211



Item	SPRINT - LINEA 2000 AUDIO KIT handset audio kit
	Kit with SPRINT handset and LINEA 2000 pushbutton panel, aluminium finish. Devices suitable for wall mounted installation.
363211	Complete one-family kit
363221	Complete two-family kit

Item	Kit composition	363211	363221
		Qty	Qty
-	LINEA 2000 Entrance panel - 1 CALL	1	-
-	LINEA 2000 Entrance panel - 2 CALLS	-	1
334202	SPRINT Audio handset	1	2
336000	6 DIN System power supply	1	1

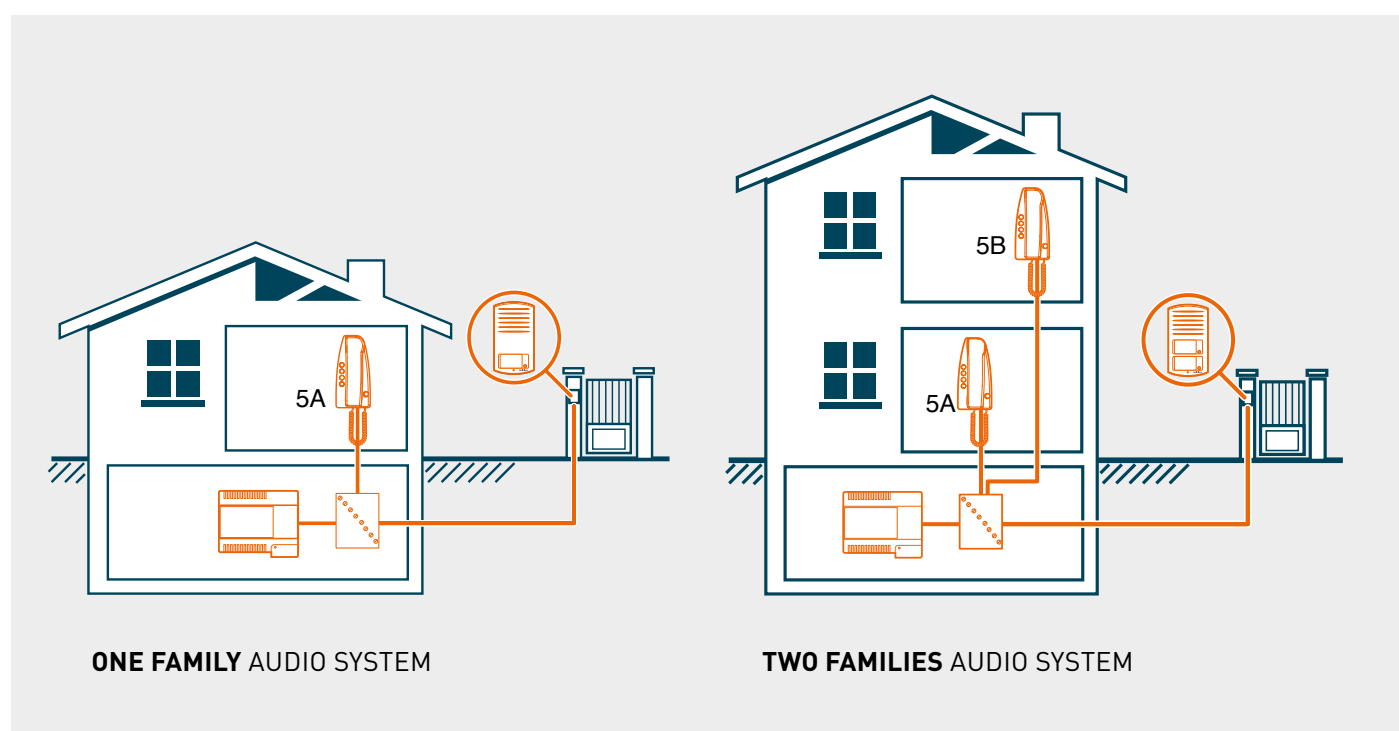



363811



Item **SPRINT - LINEA 2000 AUDIO handset kit**
363811 One-family kit with SPRINT handset and LINEA 2000 pushbutton panel. Analogue technology with 2 wire connection. Devices suitable for wall mounted installation. Expansion possibility using the specific additional handset **331550**

Item	Kit composition	Qty
-	LINEA 2000 Entrance panel	1
-	SPRINT audio handset	1
336842	2 DIN Transformer	1
Accessories		
331550	Specific additional audio handset	

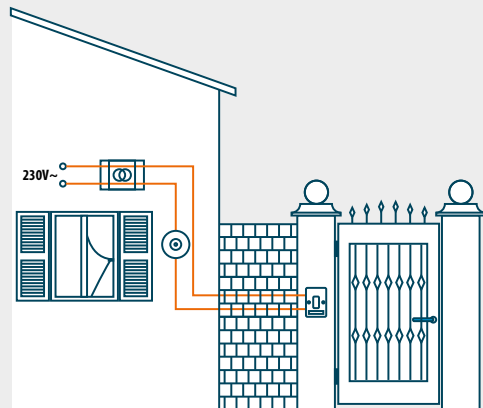

OLD BELL SYSTEM

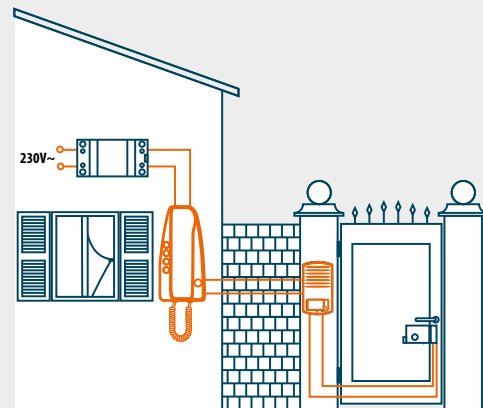

NEW AUDIO SYSTEM

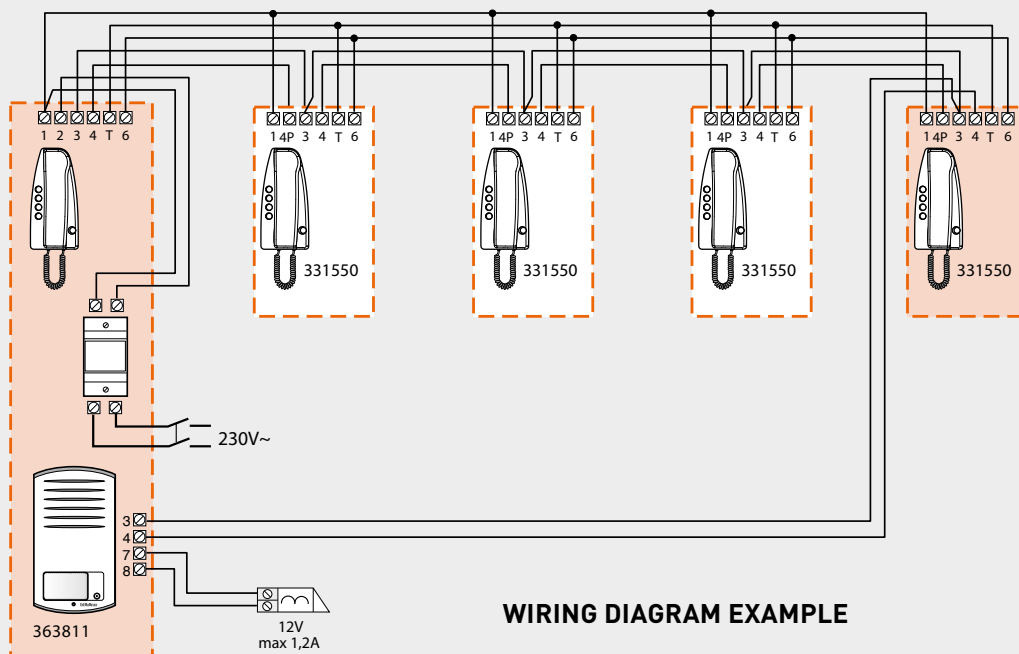

WIRING DIAGRAM EXAMPLE

2 WIRES SYSTEM

The easiest system offer



The **2 WIRES SYSTEM** is the best technology for those cases when **time saving** and **ease of installation** are crucial. Thanks to the non polarized 2 wires system it is in fact possible to install, with the same ease, all kinds of systems, from those for single villas to those for apartment complexes.

This technology is particularly suitable, for example, for:

SMALL AND MEDIUM SIZE SYSTEM



THE VILLA

RENOVATIONS



The possibility of using existing cables makes it the ideal solution when refurbishing systems.



THE APARTMENT



Remove the old entrance panel being replaced.

Use the two cables already present to connect the new entrance panel.



In addition to the extreme simplicity, the system offers **VERY GOOD PERFORMANCE**

SYSTEM MAIN FEATURES	3900	Apartments
	3900	Apartment video entrance panels
	39	Risers with independent sound mode
	5	Handsets per apartment
	600 m	Distance between entrance panel and farthest internal unit

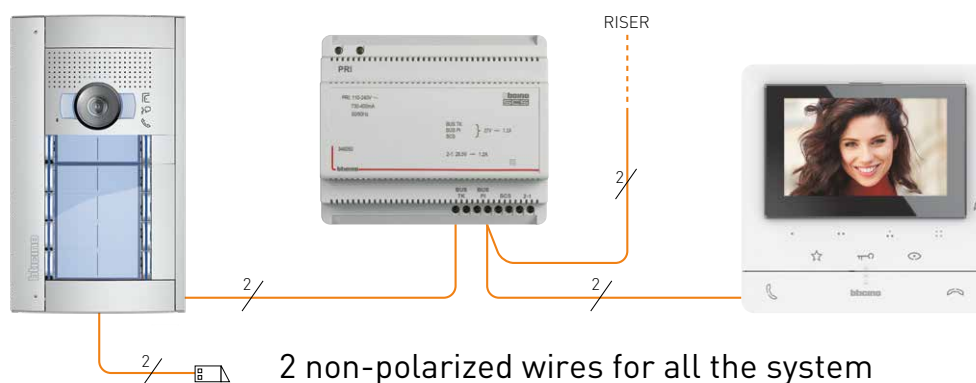

THE 2 WIRES SYSTEM

offers a wide range of entrance panels and internal units, to meet all the customer needs.

THE SYSTEM COMPOSITION

 2 WIRES



■ Thanks to the use of accessory devices, additional door locks can be **activated and/or lights switched on**.

A few accessory devices are needed to make the **2-WIRE systems**, as well as the entrance panels and the internal units and/or video internal units.



AUDIO DOOR ENTRY SYSTEM

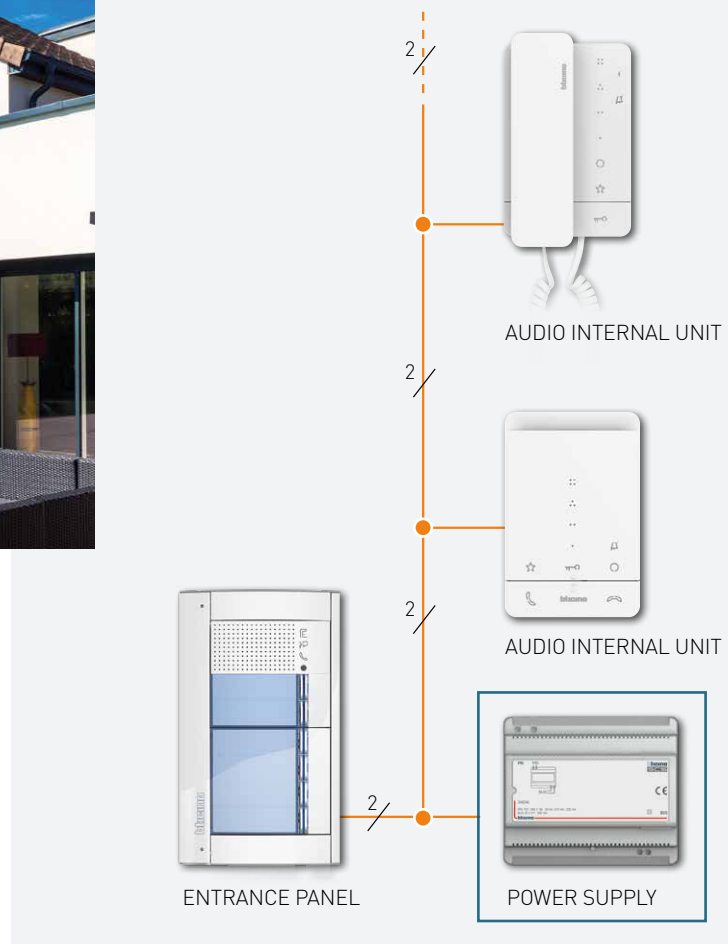



■ In apartment-block systems the switchboard can be used for **the management and centralised supervision** of the apartment-block services.



■ In systems with Classe 300EOS / Classe 100X16E connected internal units, you can **manage your door entry system calls and functions with your smartphone** thanks to the dedicated Home + Security App and with you voice (C300EOS only).



VIDEO DOOR ENTRY SYSTEM

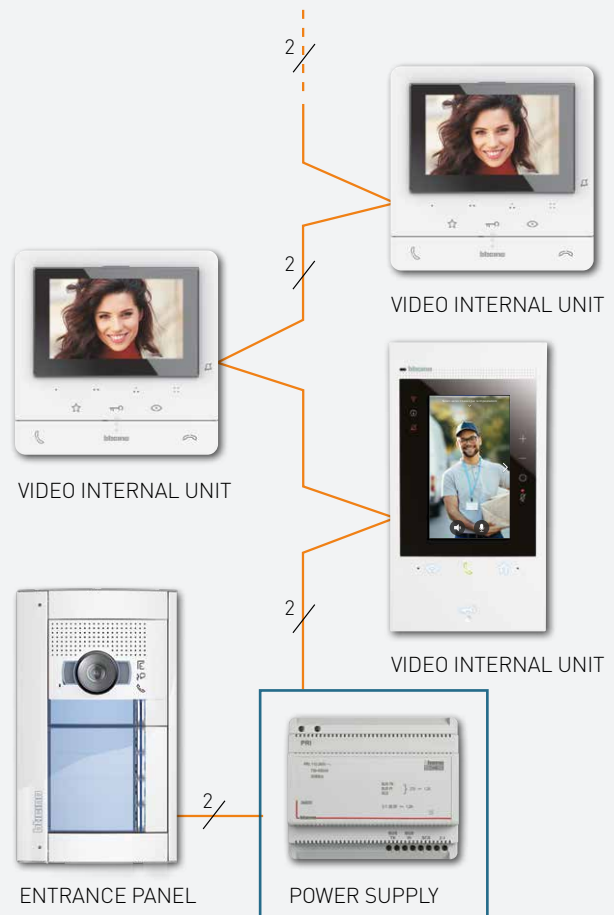



ENTRANCE PANELS RANGE

- > LINEA SFERA
- > LINEA 3000
- > LINEA 2000
- > LINEA 100
- > LINEA 300



LINEA 3000



LINEA 2000



LINEA 300



LINEA 100



SFERA NEW



SFERA ROBUR

2 WIRES SYSTEM

ENTRANCE PANELS

Overview and features

	Linea Sfera New	Linea Sfera Robur	Linea 3000
			
Audio	●	●	●
Colour video	●	●	●
Finishes / Colours	Allmetal Allwhite Allstreet	Zamak Robur	Zamak grey Zamak black
Wall mounted installation	●	●	●
Flush mounted installation	●	●	●
Pushbutton call	●	●	●
Digital call	●	●	
Wide angle camera (1)	●	●	●
Night & Day camera (2)	●	●	
Control speech synthesis (3)	●	●	
Door lock release with keypad	●	●	
Door lock release with key card	●	●	●
Rainshield	●	●	●
Vandal proof			
Protection index	IP54	IP54	IP54
Sturdiness index	Up to IK08	IK10	IK10
Max. number of calls	100 with pushbuttons 4000 with digital call	100 with pushbuttons 4000 with digital call	2

(1) Horizontal and vertical wide viewing field. Easy to use for children and differently-abled people.

(2) Night lighting thanks to the IR LED with automatic IR filter. Sharp, perfect images even in limited light conditions.

(3) Inductive loop and control speech synthesis. Use by people wearing hearing aids. Easy to use for visually impaired people.



Linea 2000	Linea 300	Linea 100
		
●		●
●	●	
Aluminium	Stainless Steel Aluminium	Stainless Steel
●	●	●
	●	
●	●	●
		●
		●
		●
		●
		●
		●
		●
		●
		●
	●	
IP54	IP54	IP44
IK07	IK07	IK08
2 (up to 4 calls - audio version only)	32 with pushbuttons 4000 with digital call	8 with pushbuttons 4000 with digital call

2 WIRES SYSTEM
ENTRANCE PANEL
SFERA

TWO STYLES ONE ELECTRONIC HEART

2-wires simplicity, maximum performance

Exceptional audio and video performance as well as fast and simple installation can be achieved with 2-wires technology.

- Up to 4000 dwellings
- 20 handsets per dwelling
- Up to 96 video entrance panels
- Operable range of 600 m between entrance panel and internal unit

SFERA ROBUR

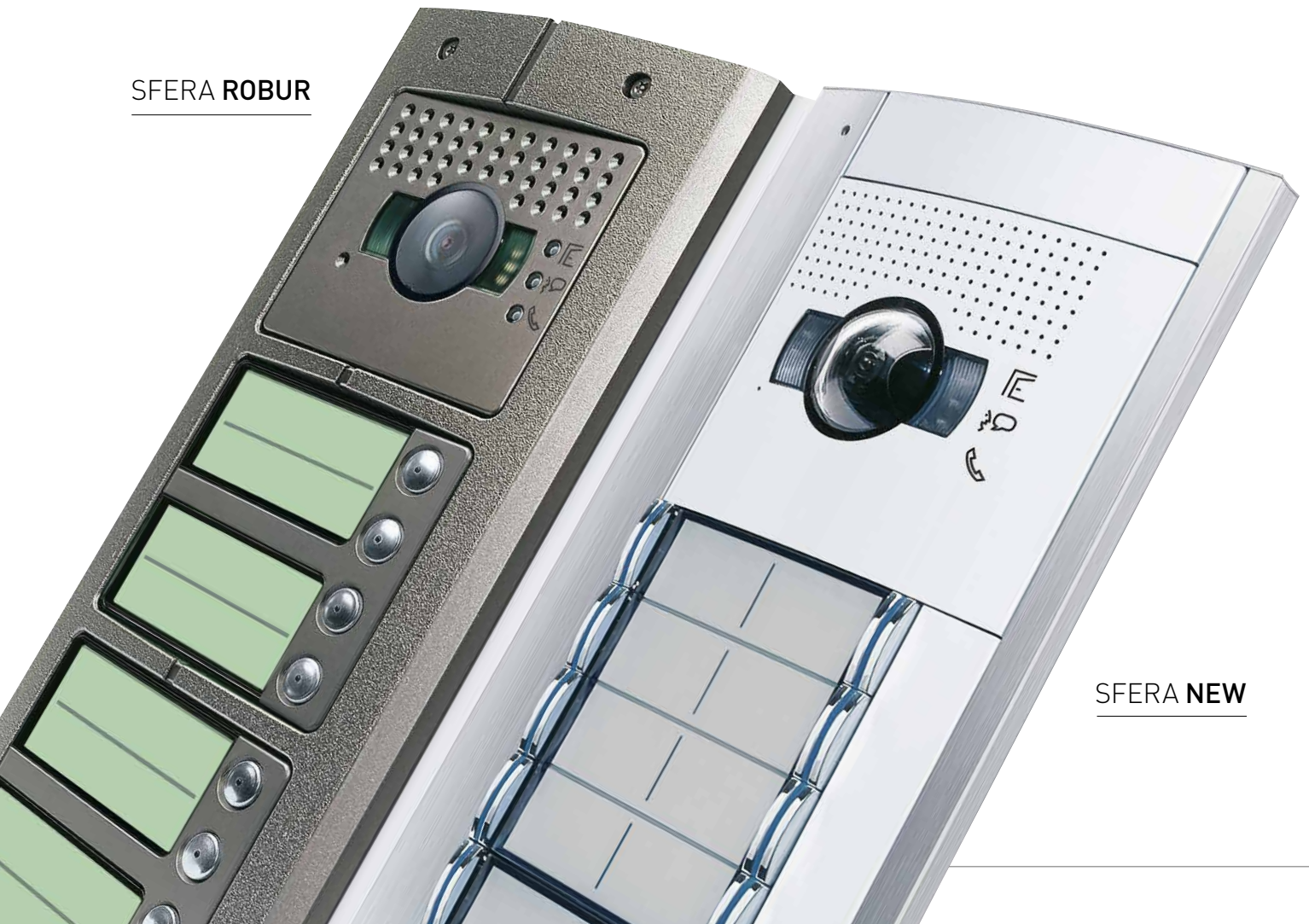

SFERA NEW

2 DESIGNS



SFERA NEW

A modern and sleek design suitable for residential and commercial developments.



Audio or video pushbutton entrance panel

Call from address book



SFERA ROBUR

Sturdy materials and optional flush-mounting boxes providing increased safety and preventing removal of the device.



Audio or video pushbutton entrance panel

Digital call



12 FUNCTIONS

TRADITIONAL

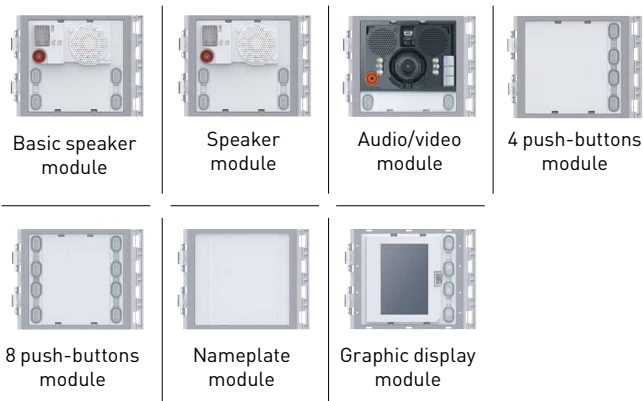

ADVANCED



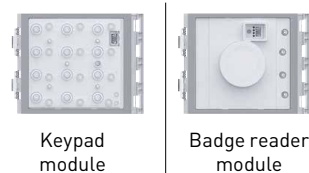

DOOR LOCK RELEASE



2 WIRES SYSTEM



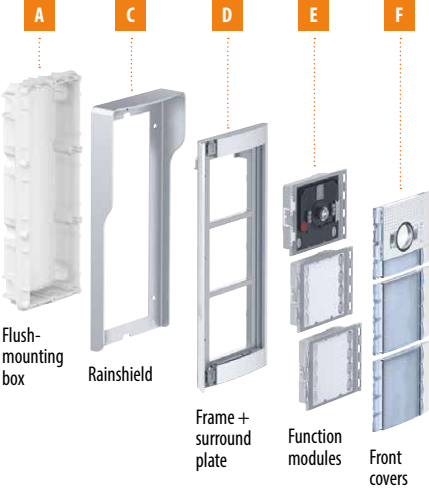

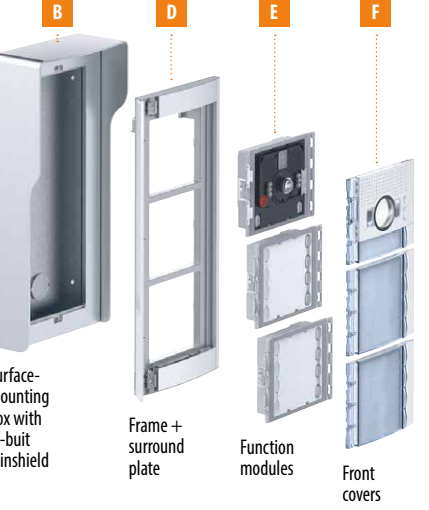





























SFERA NEW

Examples to select parts of the system

Finishes	Installation type	Flush-mounting boxes		Rainshields (optional)		Frames/plates		
		Cat.Nos	Pack	Cat.Nos	Pack	Cat.Nos	Pack	
ALLMETAL (SILVER)  1	FLUSH-MOUNTING INSTALLATION 	A		C		D		
		350010 1 module	1	35051.. 1 module	35054.. 4 modules	1	35021.. 1 module	1
		350020 2 modules	1	35052.. 2 modules	352500 6 modules	1	35022.. 2 modules	1
ALLWHITE (WHITE)  2	FLUSH-MOUNTING INSTALLATION	350030 3 modules	1	35053.. 3 modules	35059.. 9 modules	1	35023.. 3 modules	1
		Installation type		Surface-mounting boxes		Frames/plates		
		SURFACE-MOUNTING INSTALLATION		Cat.Nos		Pack	Cat.Nos	Pack
ALLSTREET (GREY)  3				B		D		
				35061.. 1 module	35064.. 4 modules	1	35021.. 1 module	1
				35062.. 2 modules	35066.. 6 modules	1	35022.. 2 modules	1
		35063.. 3 modules		35069.. 9 modules	1	35023.. 3 modules	1	

CHOOSE YOUR FINISH: Replace the dots in the Cat. No. with either 1, 2, or 3 to select the desired finish











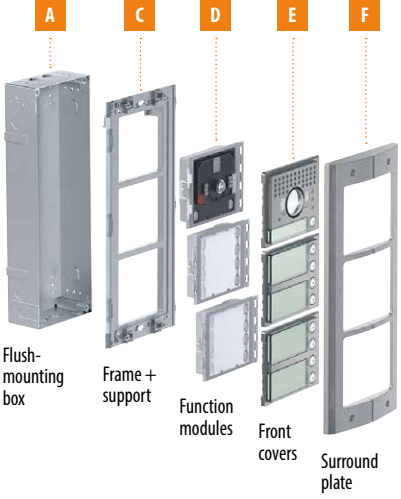









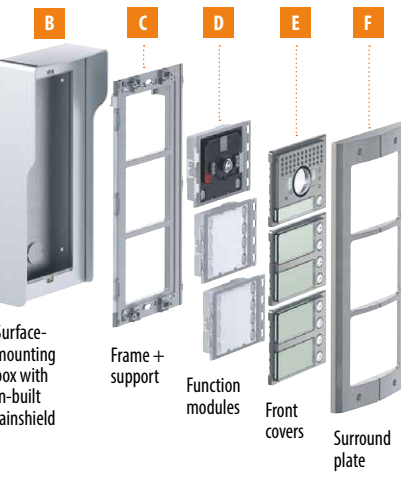



		Digital function modules		Front covers							
		Cat.Nos	Pack	Cat.Nos				Pack			
Speakers	E	351000 Basic speaker module (FOR AUDIO SYSTEMS ONLY)	1	F Audio front covers							
				 35100.. Basic speaker module	 35101.. Basic speaker module 1 push-button	 35102.. Basic speaker module 2 push-buttons	 35104.. Basic speaker module 2 push-buttons/double row	 35108.. Basic speaker module 4 push-buttons/double row	1		
		351100 Speaker module	1	 35110.. Speaker module	 35111.. Speaker module 1 push-button	 35112.. Speaker module 2 push-buttons	 35114.. Speaker module 2 push-buttons/double row	 35118.. Speaker module 4 push-buttons/double row	1		
Push-buttons		352000 4 push-buttons/ single row	1	 35203.. 3 push-buttons	 35204.. 4 push-buttons	 352011 1 push-button	 352021 2 push-buttons		1		
		352100 8 push-buttons/ double row	1	 35216.. 6 push-buttons/double row	 35218.. 8 push-buttons/double row	 352121 2 push-buttons/double row	 352141 4 push-buttons/double row		1		
Cameras	E	351200 Audio/video	1	F Video front covers							
				 35120.. Audio/video	 35121.. Audio/video 1 push-button	 35122.. Audio/video 2 push-buttons/double row			1		
		351300 Audio/video with wide angle camera	1	 35130.. Audio/video wide angle	 35131.. Audio/video wide angle 1 push-button	 35132.. Audio/video wide angle 2 push-buttons / double row		 354000 Cable for the connection or several push-button modules L= 470 mm	1		
	352400 Night/day with wide angle camera	1	 35240.. Night/day with wide angle camera						1		
Miscellaneous	E	F Miscellaneous front covers									
		352200 Name plate	1	 35220.. Name plate						1	
		352500 Graphic display	1	 35250.. Graphic display						1	
		352700 Inductive loop and control speech synthesis	1	 35270.. Inductive loop-speech synthesis					 35230.. Blanking reader	1	
		353200 Badge reader	1	 35320.. Badge reader						1	
	353000 Keypad	1	 35300.. Numeric keypad	 353011 Alphanumeric keypad					1		

2 WIRES SYSTEM



































SFERA ROBUR

Examples to select parts of the system

Finishes	Installation type	Flush-mounting boxes		Support frames		Frames/plates	
	FLUSH-MOUNTING INSTALLATION	Cat.Nos	Pack	Cat.Nos	Pack	Cat.Nos	Pack
<p>VANDAL-RESISTANT (ROBUR)</p> 		 350110 1 module	1	 350315 1 module	1	 350415 1 module	1
		 350120 2 modules	1	 350325 2 modules	1	 350425 2 modules	1
		 350130 3 modules	1	 350335 3 modules	1	 350435 3 modules	1
	Installation type	Surface-mounting boxes		Support frames		Frames/plates	
	SURFACE-MOUNTING INSTALLATION	Cat.Nos	Pack	Cat.Nos	Pack	Cat.Nos	Pack
		 35061.. 1 module	1	 350315 1 module	1	 350415 1 module	1
 35062.. 2 modules		 35064.. 4 modules	1	 350325 2 modules	1	 350425 2 modules	1
 35063.. 3 modules		 35066.. 6 modules	1	 350335 3 modules	1	 350435 3 modules	1

(*) CHOOSE YOUR FINISH: Replace the dots in the Cat. No. with either 1, 2, or 3 to select the desired finish - Refer to SFERA NEW finishes.



	Digital function modules		Front covers					
	Cat.Nos	Pack	Cat.Nos					Pack
Speakers	E  351000 Basic speaker module (FOR AUDIO SYSTEMS ONLY)	1	F Audio front covers					
	 351100 Speaker module	1	 351005 Basic speaker module	 351015 Basic speaker module 1 push-button	 351025 Basic speaker module 2 push-buttons	 351045 Basic speaker module 2 push-buttons/double row	 351085 Basic speaker module 4 push-buttons/double row	1
Push-buttons	 352000 4 push-buttons/ single row	1	 352035 3 push-buttons	 352045 4 push-buttons				1
	 352100 8 push-buttons/ double row	1	 352165 6 push-buttons/double row	 352185 8 push-buttons/double row				1
Cameras	E  351200 Audio/video	1	 351205 Audio/video	 351215 Audio/video 1 push-button	 351225 Audio/video 2 push-buttons / double row			1
	 351300 Audio/video with wide angle camera	1	 351305 Audio/video wide angle	 351315 Audio/video wide angle 1 push-button	 351325 Audio/video wide angle 2 push-buttons / double row	 354000 Cable for the connection or several push-button modules L= 470 mm		1
	 352400 Night/day with wide angle camera	1	 352405 Night/day with wide angle camera					1
Miscellaneous	E  352200 Name plate	1	 352205 Name plate					1
	 352500 Graphic display	1	 352505 Graphic display					1
	 352700 Inductive loop and control speech synthesis	1	 352705 Inductive loop-speech synthesis	 352305 Blanking reader				1
	 353200 Badge reader	1	 353205 Badge reader					1
	 353000 Keypad	1	 353005 Keypad					1

2 WIRES SYSTEM

SFERA

Electronic modules

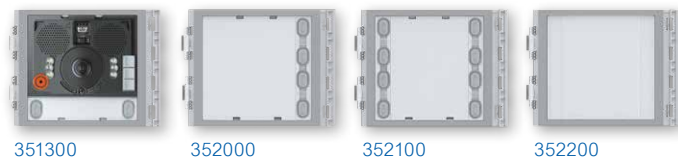

Item	Electronic modules
351000	Basic speaker module for the creation of 2 WIRE audio systems. Fitted with loudspeaker and microphone volume adjustment. It manages up to 100 pushbutton calls using additional double row pushbuttons. It can be used for opening an electrical door lock directly connected to the S+ and S- clamps (18 V 4 A impulsive - 250 mA holding current 30 Ohm max) and the connection to a local door lock release pushbutton on the PL clamps. To be completed with surround plate. The device must be physically configured.
351100	Speaker module for the creation of 2 WIRE audio & video systems. Fitted with loudspeaker and microphone volume adjustment. It can manage up to 100 pushbutton calls when using additional double row pushbutton modules. It can be used for opening an electrical door lock directly connected to the S+ and S- clamps (18 V 4 A impulsive - 250 mA holding current 30 Ohm max) and the connection to a local door lock release pushbutton on the PL clamps. Preset for additional power supply. Fitted with front LEDs for the notification of the operating status: door lock release, communication active, call put through, and system busy. Integrated optic sensor for the switching on of the night backlighting. To be completed with surround plate. The device can be configured either physically or using the PC and the TiSferaDesign software.
351200	Audio video module for the installation of 2 WIRE colour video systems. With Colour camera with 1/3" sensor and white LEDs for the lighting of the shooting field. Mist prevention heating resistance. Loudspeaker and Microphone volume adjustments. It can manage up to 98 pushbutton calls using the additional double row pushbutton modules. Horizontal and vertical camera position adjustment, +/- 10° in both directions. It offers the possibility of opening an electrical door lock directly connected to clamps S+ and S- (18 V 4 A impulsive - 250 mA holding current 30 Ohm max) and of connecting a local door lock release pushbutton on clamps PL. Preset for additional power supply. Fitted with front LEDs for the notification of the operating status: door lock release, communication active, call put through, and system busy. Integrated optic sensor for the switching on of the night backlighting. To be completed with surround plate. The device must be configured physically or using a PC and the TiSferaDesign software.

Item	Electronic modules
351300	Wide angle audio/video module for the installation of 2 WIRE colour video systems. With Colour camera with 1/3" sensor and white LEDs for the lighting of the shooting field. Mist prevention heating resistance. Loudspeaker and Microphone volume adjustments. It can manage up to 98 pushbutton calls using the additional double row pushbutton modules. It offers the possibility of opening an electrical door lock directly connected to clamps S+ and S- (18 V 4 A impulsive - 250 mA holding current 30 Ohm max) and of connecting a local door lock release pushbutton on clamps PL. Preset for additional power supply. Fitted with front LEDs for the notification of the operating status: door lock release, communication active, call put through, and system busy. Integrated optic sensor for the switching on of the night backlighting. To be completed with surround plate. The device must be configured physically or using a PC and the TiSferaDesign software
352000	Additional 4-pushbutton modules arranged on single column. To be used with speaker modules 351000 - 351100 and audio/video modules 351200 - 351300. Connection using the appropriate multicable supplied. Backlighting of nameplates controlled by the speaker module or the audio/video module connected. To be completed with surround plate
352100	Additional 8-pushbutton modules arranged on double column. To be used with speaker modules 351000 - 351100 and audio/video modules 351200 - 351300. Connection using the appropriate multicable supplied. Backlighting of nameplates controlled by the speaker module or the audio/video module connected. To be completed with surround plate
352200	Nameplate module normally used for displaying the house number or other notifications (e.g. Legend for calls using digital pushbutton panels, opening/closing times, etc.). Connection using the appropriate multicable supplied. Night backlighting controlled by the speaker module or the audio/video module connected. To be completed with surround plate



Item	Electronic modules
352400	Night & Day and wide angle camera module for the installation of colour video systems. Fitted with 1/3" sensor with N&D function and automatic removal of the IR filter. IR LED for the lighting of the field of view. Mist prevention heating resistance. Automatic brightness adjustment. Connection to the speaker module (351100) using the multicable supplied. To be completed with surround plate
352500	Graphic display module to be used with speaker module 351100 or with audio/video modules 351200 - 351300 (connection using the multicable supplied). It can operate in two modes: call from address book, or digital call. The call from the address book gives the possibility of sending the call by scrolling on the display the names associated to the residents. It is possible to store up to 4000 residents names. Using the keypad module item 353000 it is also possible to directly call the apartment by entering the number corresponding to the resident. The digital call is also performed using the keypad module item 353000 by entering the numerical code. It is recommended that one or more nameplate modules, item 352200, are installed at the side of the pushbutton panel to display the correspondence between the numerical codes and the names of the users. It is possible to program the names in the address book in two different ways: manual inclusion using the pushbuttons of the display module or inclusion using a PC with the TiSferaDesign software installed, by downloading the file to the display module (RECOMMENDED). System power supply cuts do NOT cause the loss of memory data. To be completed with surround plate
352700	Inductive loop and control speech synthesis module to be used with the 351100 speaker module or with audio/video modules 351200 - 351300. Enable use by people wearing hearing aids (fitted with T selector) or blind people thanks to the connection status voice message synthesis (call active, call ended, no answer, busy, door open). It is connected to the speaker module using the appropriate multicable supplied. To be completed with surround plate. The device can be configured either physically or using the PC and the TiSferaDesign software

Item	Electronic modules
353000	Keypad module for door lock release, or for the digital call of the apartment (to be used with the display module). It is fitted with relay with contacts (C - NC - NO) and clamps (CP- P1 - P2) for the connection of a local door lock release pushbutton. The numerical code for the opening of the door lock can be programmed using the keypad itself, or using a PC after downloading the module programming file. It also has a programming reset pushbutton and LEDS for the visual notification of the access status. Night backlighting with LEDs. To be completed with surround plate. It is connected to the other modules using the appropriate multicable supplied. The device may also be used as a stand alone unit with independent power supply and operation per la sola apertura serratura. Configuration performed using physical configurators, or a PC with the TiSferaDesign software installed
353200	RFID badge reader module for the release of the door lock by swiping the badge. It manages up to 20000 badges. It's fitted with relay contacts (C - NO - NC) and clamps (CP - P1 - P2) for the connection of a local door release pushbutton. The badge for the release of the door lock can be programmed from the module itself, or using a PC after downloading the module programming file. It also has a programming reset pushbutton and LEDS for the visual notification of the access status. Night backlighting a LEDs. To be completed with surround plate. It is connected to the other modules using the appropriate multicable supplied. The device may also be used as a stand alone unit with independent power supply and operation. Configuration performed using physical configurators, or a PC with the TiSferaDesign software installed
346993	Expander pushbutton module that gives the possibility of connecting call pushbuttons to the SFERA speaker modules (items 351000; 351100; 351200; 351300). Each module can manage up to 8 call pushbuttons. It is possible to connect several expander pushbutton modules (max 96 call pushbuttons for each Entrance Panel)

Transponder keys and programmer	
348200	Black transponder key
348201	Red transponder key
348202	Green transponder key
348203	Blue transponder key
348204	Orange transponder key
348205	Grey transponder key
348206	Yellow transponder key
348402	Table-top transponder key programmer

LINEA 3000

One entrance panel for every need

LINEA 3000 can be configured both for 1 and 2 family house



ONE
FAMILY HOUSE



- Write the name on the one family nameplate label (supplied with the product).
- Set the internal micro-switch on position 1.

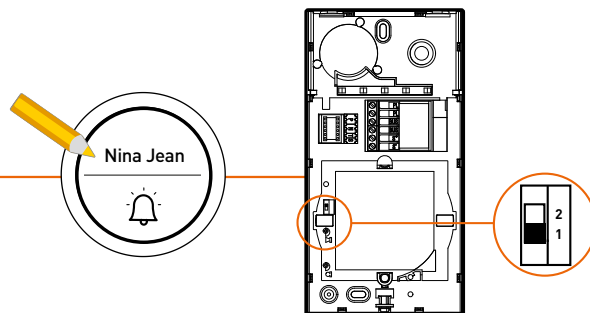

TWO
FAMILY HOUSE



- Replace the nameplate label with the two family one (supplied with the product).
- Write the names on the two family nameplate label
- Set the internal micro-switch on position 2.

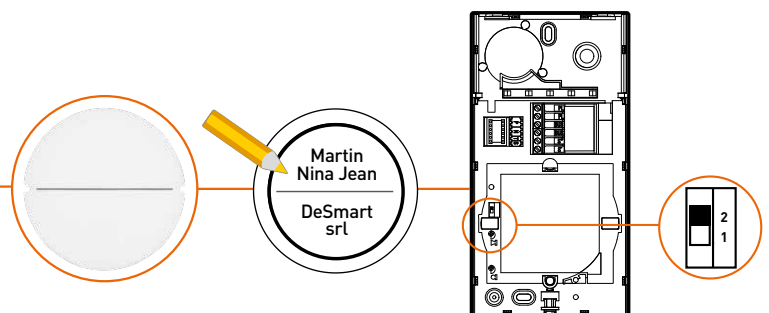



LINEA 3000 inside of the new professional kits

For **ONE FAMILY** house installation, you have to buy only the kit and all you need is inside it.

For **TWO FAMILY** house installation, you have to buy the kit + an additional 2 wires internal unit. (refer to 2 wires system internal units range).

High installation flexibility

- **LINEA 3000** is sold for wall mounting installation but with the dedicated **accessories** (to be purchased separately), you can use the entrance panel for **flush mounting installation**.

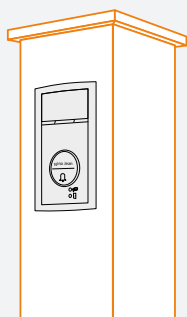

Also available in black version.

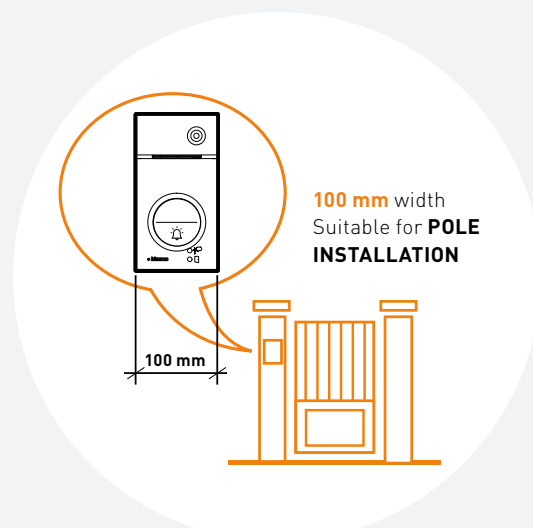

Ideal for renovations.....you can reuse the existing flush mounted box.
Same 2 Modules Tersystem and SFERA flush mounting box.

- **LINEA 3000** can be wall mounted with the dedicated **(343051) rainshield accessory** (to be purchased separately).

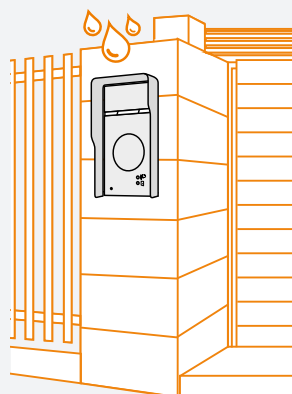

Also available in black version.

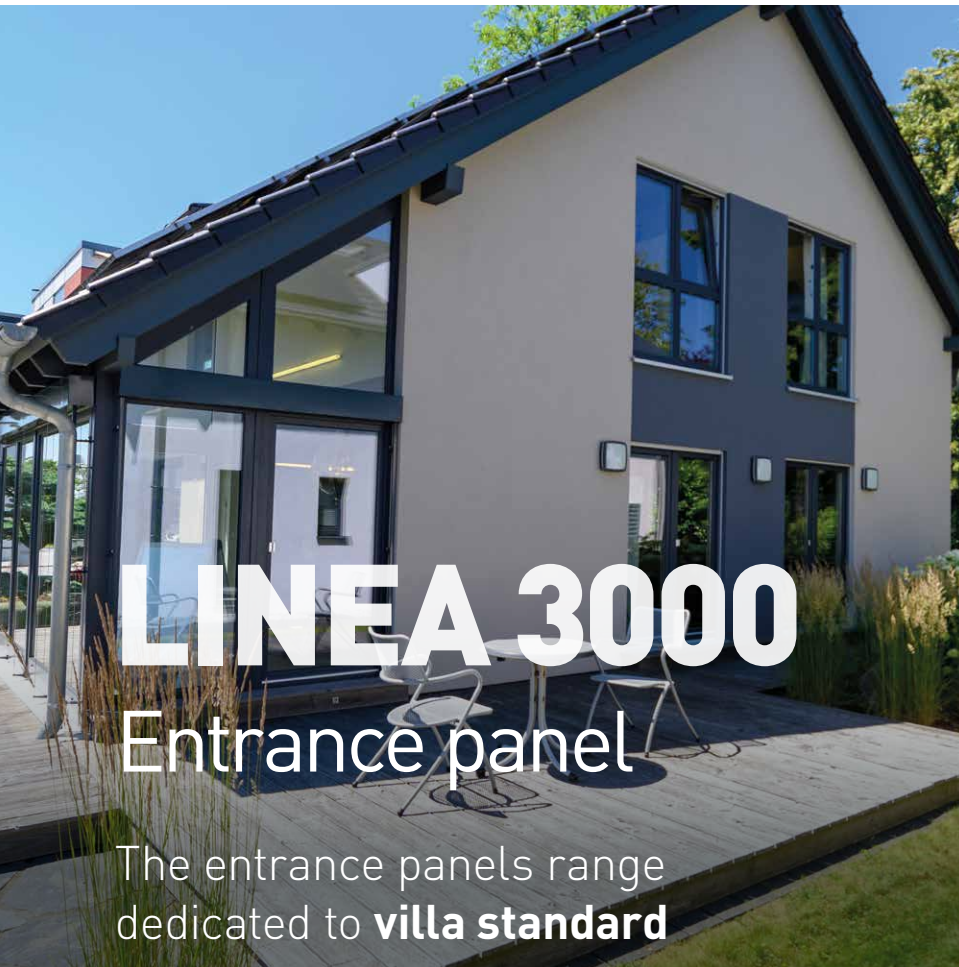

LINEA 3000

Entrance panel

The entrance panels range dedicated to **villa standard**

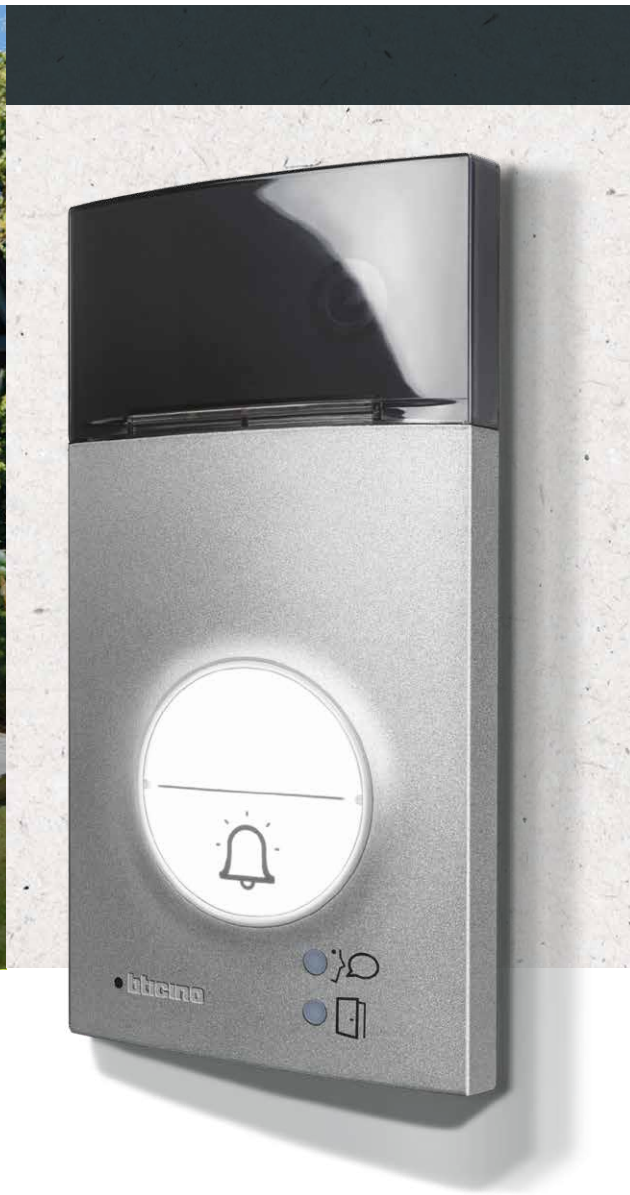

Unique design and robust perception

Same look and ergonomics for all available versions:

LINEA 3000 video with door lock release badge



343093



343091



LINEA 3000 video



343081

LINEA 3000 audio



343071



HIGH LEVEL APPLICATIONS

Modern aesthetics feeling of quality



refined detailing



branded quality



floating effect



hidden technology



high relevance on interaction

robustness
Zamak finishes



Weatherproof
(IP 54)
protection degree



Robustness
(IK 10)
protection degree

Advanced functions

WIDE ANGLE CAMERA

Horizontal and vertical wide viewing field. Easy to use for children and differently-abled People.



DOOR LOCK RELEASE

Door lock release with coloured badges or clear discs. Additional safe and comfort for all the residents.



2 WIRES SYSTEM

ENTRANCE PANEL

LINEA 3000



343091

343093

343081

343071



348260

348261

Item	LINEA 3000 Video entrance panel with door lock release proximity reader
343091	Wall mounted 2-Wires video pushbutton panel with Zamak front cover, wide angle colour camera and proximity reader. Fitted with white LED for the lighting of the shooting field in low light conditions. Can be set up for one or two family installation. It provides the possibility of opening an electrical door lock connected directly to clamps S+ and S- (18 V 4 A impulsive, 250 mA holding current, 30 ohm max). Can manage a maximum of 20 badges (125 KHz) for electrical door opening (master system badge included). White LED backlight name plate. Protection degree IP54 – protection against mechanical impact IK10. Supplied 1 set of door opening badges made up of : 6 coloured badges and 2 clear discs.
343093	Same as 343091 but in black finish

Item	LINEA 3000 Spare part front covers
343082	Spare part front cover for video entrance panels 343081 and 343091.
343072	Spare part front cover for audio entrance panel 343071.
Door lock release badge and clear disc	
348260	Set made up of 6 coloured badges which can be programmed to open the door
348261	Set made up of 2 programmable clear discs which can be programmed to open the door

Item	LINEA 3000 Video entrance panel
343081	Wall mounted 2-Wires video pushbutton panel with Zamak front cover and wide angle colour camera.. Fitted with white LED for the lighting of the shooting field in low light conditions. Can be set up for one or two family installation. It provides the possibility of opening an electrical door lock connected directly to clamps S+ and S- (18 V 4 A impulsive, 250 mA holding current, 30 ohm max). White LED backlight name plate. Protection degree IP54 – protection against mechanical impact IK10.

Item	LINEA 3000 Audio entrance panel
343071	Wall mounted 2-Wires pushbutton panel with Zamak front cover. Can be set up for one or two family installation. It provides the possibility of opening an electrical door lock connected directly to clamps S+ and S- (18 V 4 A impulsive, 250 mA holding current, 30 ohm max). White LED backlight name plate. Protection degree IP54 – protection against mechanical impact IK10.



- | Item | LINEA 3000 Rainshield accessory |
|--------|--|
| 343051 | Rainshield roof accessory for Linea 3000 (343071 - 343081 - 343091) entrance panels. To be purchased separately. |
| 343053 | Rainshield roof accessory for Linea 3000 (343093) entrance panel. To be purchased separately. |

- | Item | LINEA 3000 Flush mounting accessory + plastic box |
|--------|--|
| 343061 | Flush mounting frame accessory for Linea 3000 (343071 - 343081 - 343091) entrance panels. To be purchased separately. |
| 343063 | Flush mounting frame accessory for Linea 3000 (343093) entrance panel. To be purchased separately. |
| 350020 | Plastic box suitable for the flush mounting installation of Linea 3000 entrance panels (343071 - 343081 - 343091 - 343093) together with the specific frame accessory 343061 - 343063. To be purchased separately. |



2 WIRES SYSTEM ENTRANCE PANEL LINEA 2000



343031



343032



342911



342921



342931



342941

Item	Wall mounted colour video entrance panel
343031	2 WIRE video pushbutton panel with a call key and colour camera. Fitted with white LEDs for the lighting of the shooting field in low light conditions. Aluminium front cover. Nameplate lit by green LED
343032	As item 343031, but with 2 call pushbuttons

Item	Wall mounted audio entrance panel
342911	2 WIRE audio pushbutton panel with one call pushbutton for wall mounted installation. Aluminium front cover. Nameplate lit by green LED
342921	As item 342911, but with 2 call pushbuttons
342931	As item 342911, but with 3 call pushbuttons
342941	As item 342911, but with 4 call pushbuttons



LINEA 100



343101



343102



343100

Item	Pushbuttons audio entrance panel
343101	2 WIRE audio pushbutton panel with 4 call pushbuttons for wall mounted installation. It's fitted with rainshield and internal contact (C - NO - NC) for the connection of an electrical door lock or external actuator (for the power supply to the electrical door lock allow for the installation of auxiliary transformer item 336482). Connections (PL) for a local door lock release pushbutton
343102	2 WIRE audio pushbutton panel with 8 call pushbuttons for wall mounted installation. It's fitted with rainshield and internal contact (C - NO - NC) for the connection of an electrical door lock or external actuator (for the power supply to the electrical door lock allow for the installation of auxiliary transformer item 336482). Connections (PL) for a local door lock release pushbutton

Item	Digital call audio entrance panel
343100	2 WIRE AUDIO digital call pushbutton panel for wall mounted installation. The device consists of a pushbutton panel with 16 keys and a digital display showing the operating status. Using previously saved numerical (SCS addresses) or alphanumeric (logical addresses) codes, it is possible to call the internal units, and for the residents to release the door lock using a dedicated numerical code. The pushbutton panel manages up to 4000 internal unit addresses (from 0 to 3999), as well as the direct call to the 2 WIRE switchboard. It's fitted with rainshield and internal contact (C - NO - NC) for the connection of an electrical door lock or external actuator (for the power supply to the electrical door lock allow for the installation of auxiliary transformer item 336482). Connections (PL) for a local door lock release pushbutton

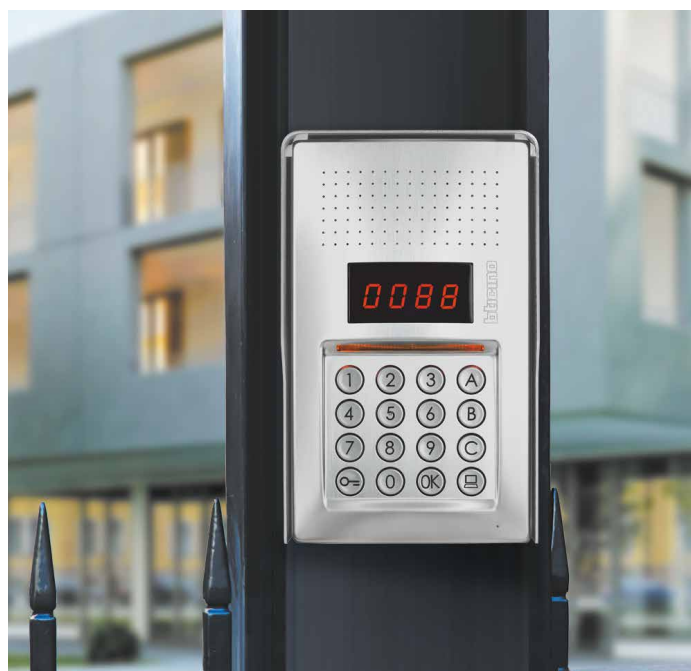

2 WIRES SYSTEM ENTRANCE PANEL LINEA 300



308001
308011

308002
308012

308003
308013

308004
308014

308022

Item	Aluminium finish pushbutton panel
308001	Monobloc vandal-resistant 2 WIRE video pushbutton panel for 2 and 4 calls with aluminium finish. The item code includes: flush mounted box, frame, colour video and audio electronic module, prewired pushbutton module/s. Presetting for the mounting of transponder reader or key switch. Backlit call keys. Visual and sound notifications of the communication status for: call active, system busy, door lock status
308002	As item 308001 but for up to 8 calls
308003	As item 308001 but for up to 12 calls
308004	As item 308001 but for up to 20 calls
308005	As item 308001 but for up to 32 calls

Item	Stainless steel finish pushbutton panel
308011	Monobloc vandal-resistant 2 WIRE video pushbutton panel for 2 and 4 calls with stainless steel finish. The item code includes: flush mounted box, frame, colour video and audio electronic module, prewired pushbutton module/s. Presetting for the mounting of transponder reader or key switch. Backlit call keys. Visual and sound notifications of the communication status for: call active, system busy, door lock status
308012	As item 308011 but for up to 8 calls
308013	As item 308011 but for up to 12 calls
308014	As item 308011 but for up to 20 calls
308015	As item 308011 but for up to 32 calls

Wall mounted boxes	
308021	Wall mounted box for pushbutton panels, items 308001-308011
308022	Wall mounted box for pushbutton panels, items 308002-308012
308023	Wall mounted box for pushbutton panels, items 308003-308013
308024	Wall mounted box for pushbutton panels, items 308004-308014
308025	Wall mounted box for pushbutton panels, items 308005-308015



308040



308026



Digital call entrance panel with flush mounting box

Item	Digital call entrance panel
308040	Monobloc vandal-resistant 2 WIRE digital call video pushbutton panel (in stainless steel), flush mounted or wall mounted installation (with specific box item 308026 sold separately). The item includes: flush mounted vandal-resistant steel box, audio and video module with wide angle colour camera, integrated graphic display, and alphanumeric keypad for direct apartment call, fast address book search, and door lock release using a code. Presetting for the installation of a T25 Vigik reader, or a key switch. Backlit display and BLUE keys. It is possible to store up to 4000 residents names. Visual, sound, or control speech synthesis communication status notification, for example: call active, system busy, door lock status. Direct control of an electric door lock 18V-4A impulsive, 250 mA holding current (30 ohm max). System power supply cuts do NOT cause the loss of memory data. Selectable display menu languages are: Italian, English and French. The device can be configured physically or using a PC with the specific software, which can be downloaded free of charge from www.homesystems-legrandgroup.com
308026	Wall mounted box for digital call entrance panel 308040

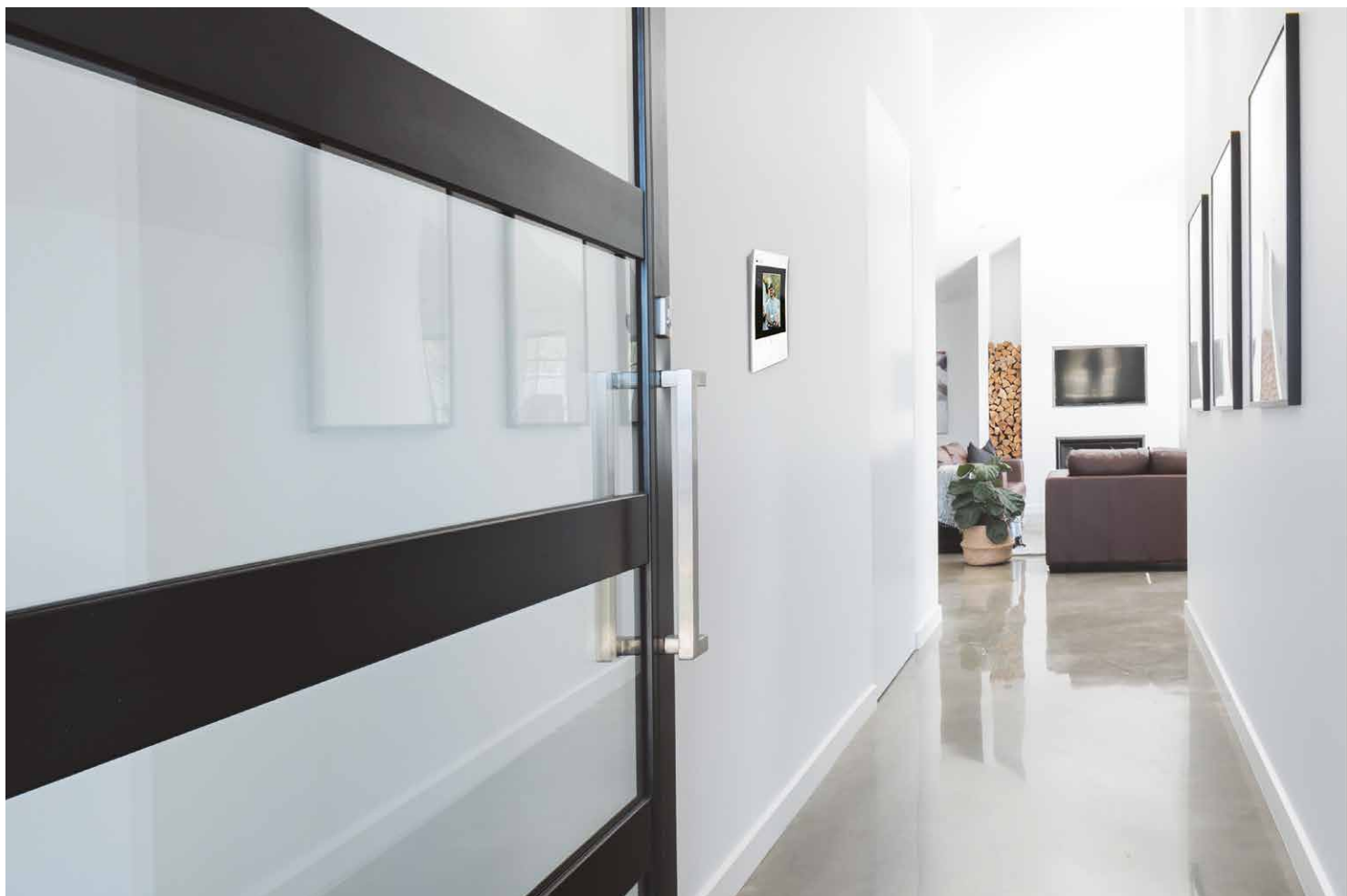

INTERNAL UNITS RANGE

- > CLASSE 300EOS
- > CLASSE 100
- > SPRINT L2



alexia | built-in



CLASSE 300E0S

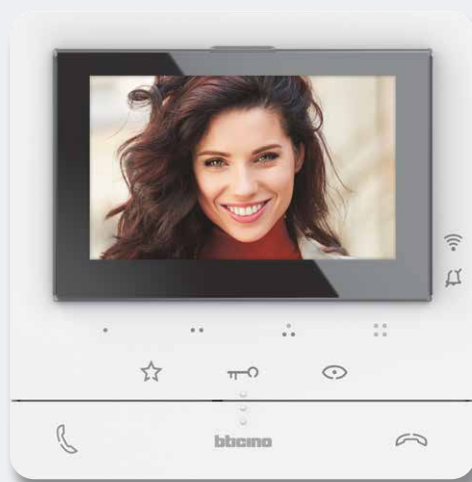

CLASSE 100X16E



CLASSE 100A16E

2 WIRES SYSTEM

INTERNAL UNITS

Overview and features

	Classe 300EOS with Netatmo	Classe 100X16E with Netatmo	Classe 100V16E
			
Audio			
Colour video	●	●	●
Handsfree	●	●	●
Call redirection on smartphone	●	●	
Integrated Alexa voice assistant	●		
Wifi connection	●	●	
Finishes / Colours	White - Black	White	White
Display	LCD Touch 5"	LCD 5"	LCD 5"
Answering machine	●		
Floor call	●	●	●
Door lock release	●	●	●
Staircase light control	●	●	●
Scrolling EP activation	●	●	●
Intercom (1)	●	●	●
Inductive loop (2)	●	●	●
Professional studio function	●	●	●
Safe door lock function	●	●	●
Note / message function	●		
Quick link / Favourite	●		
Wall-mounted installation	●	●	●
Tabletop installation		●	●

(1) The intercom function allows for up to 3-minute communication between and among video door entry systems in the same apartment / in different apartments.

(2) Use by people wearing hearing aids fitted with (T) selector.

(3) Activated with specific configuration inserted in P.



Classe 100V16B	Classe 100V16M	Classe 100A16E	Classe 100A16M	Sprint L2
		•	•	•
•	•			
•		•		
White	White	White	White	White
LCD 5"	LCD 4,3"			
•	•	•	•	•
•	•	•	•	•
•	•	•	•	• (3)
•	•	•	•	• (3)
•	•	•	•	
		•	•	
•	•	•	•	
	•			
•	•	•	•	•
•		•	•	

CLASSE 300EOS

THE EVOLUTION OF SMART

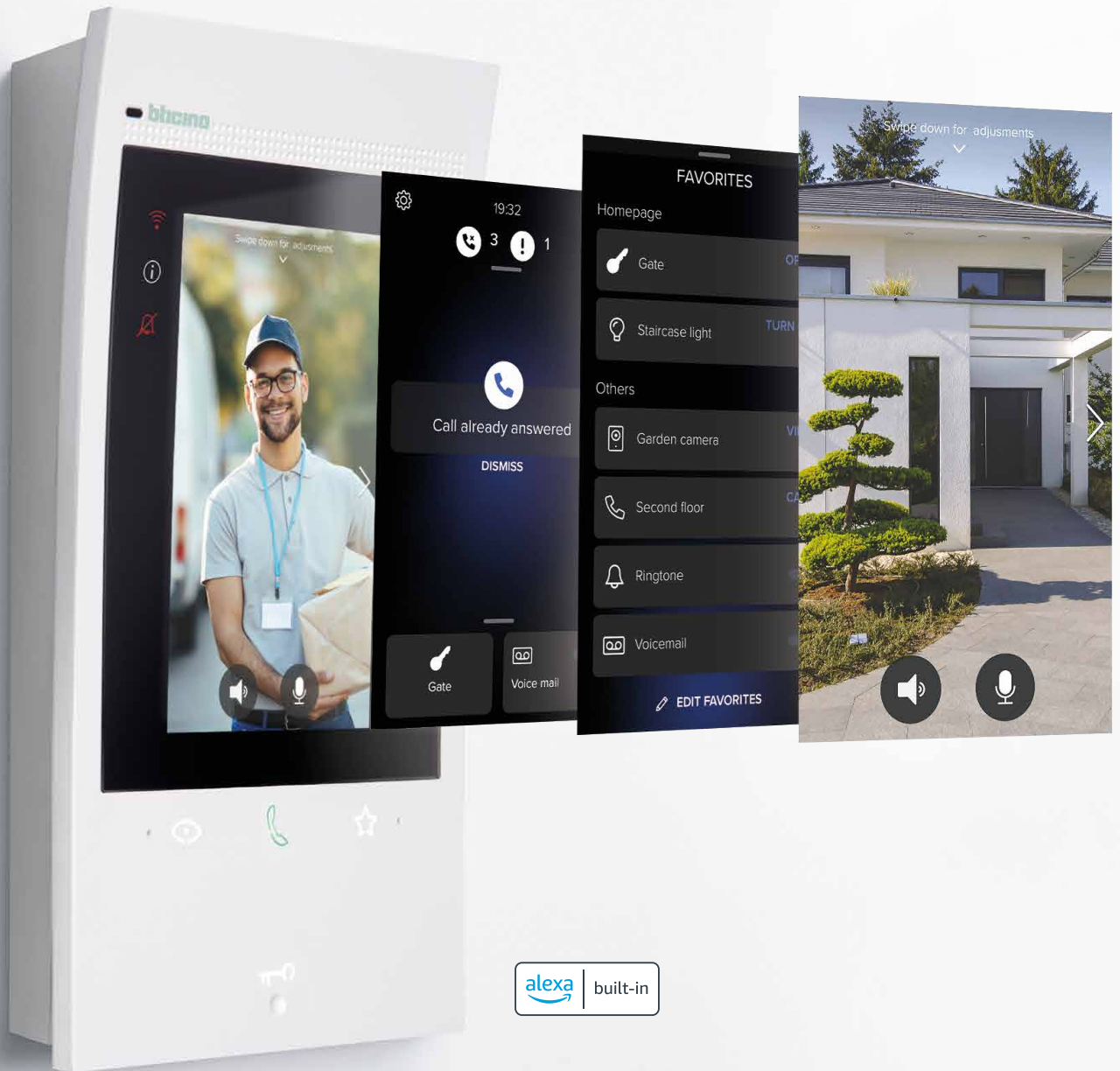

Video door
entry system



Management
with smartphone



Voice
control



Smart
Home



Smart
Security



Classe 300EOS with Netatmo is the 2 wires / Wi-Fi handsfree connected video internal unit with built-in Amazon Alexa voice assistant. Using the Home + Security App, in addition to video door entry calls, it is also possible to manage the devices of the Netatmo security range, creating a simple and fast Smart security system.

CLASSE
300EOS | WITH Netatmo

Change your idea of a video internal unit.

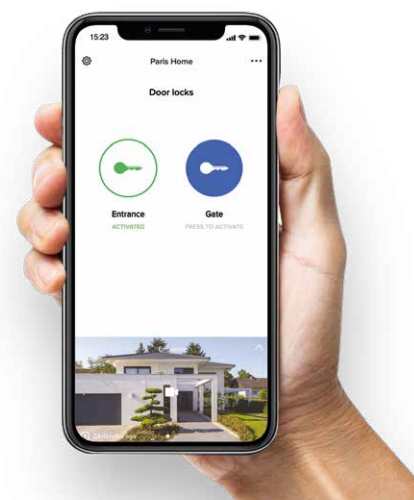

2 WIRES SYSTEM
INTERNAL UNITS
CLASSE 300EOS with Netatmo



The smart vision of the home.

Distinctive design to meet the needs of contemporary living. Vertical and super slim. With its clean and modern design, it gives every type of home an innovative look, and offers a unique user experience.



Vertical display and curved shape: a disruptive and modern design, but also understated.

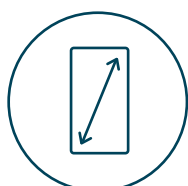

5" Touch Screen

Vertical display for a better view of the caller

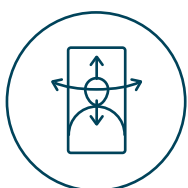
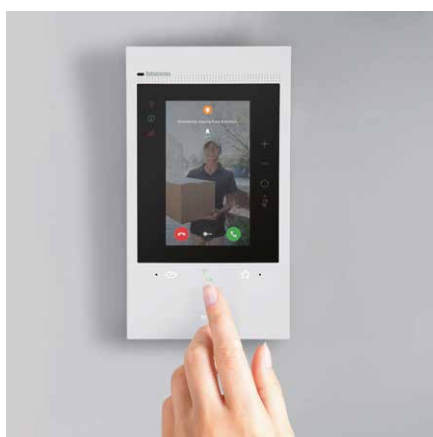

Face detection

Automatic centring of the subject on the display

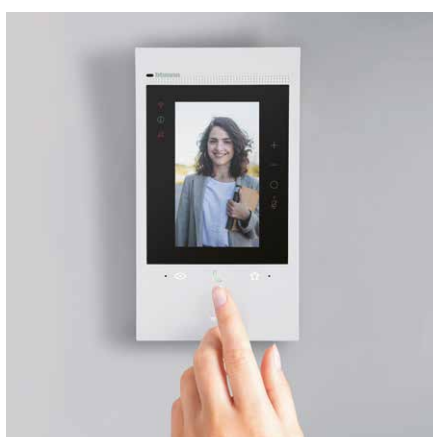

Horizontal display

Double "tap" the display to view the image in landscape format



Curved shape

The shape of a welcome: a "welcoming effect" for residents and guests.



2 WIRES SYSTEM
INTERNAL UNITS
CLASSE 300EOS with Netatmo

Always aware with the Home + Security App



Home + Security

The best App for a safe home

Alerts and notifications for incoming calls, motion and people detection, event information and door lock management with a simple and intuitive interface.





Answer the calls,
activate the electrical door locks,
activate the cameras and display
the timeline of the events

Manage up to 20 homes
with your single account



Home + Security



Incoming call
Receive notification
when someone
is calling

See who's calling
Answer the call and
open the gate for
the courier

Check the events
Check who called you
and if they left you
a message

Quick actions

- Activate the electrical door locks
- Activate the timed staircase lights
- Call home / Intercom
- Activate the cameras
- Manage the video door entry answering machine

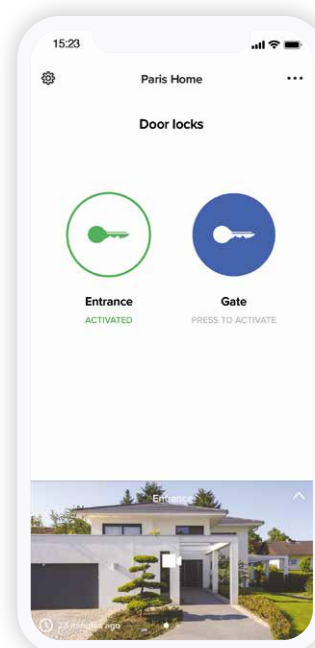
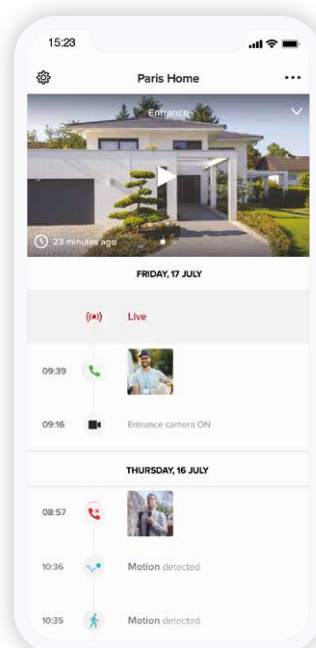
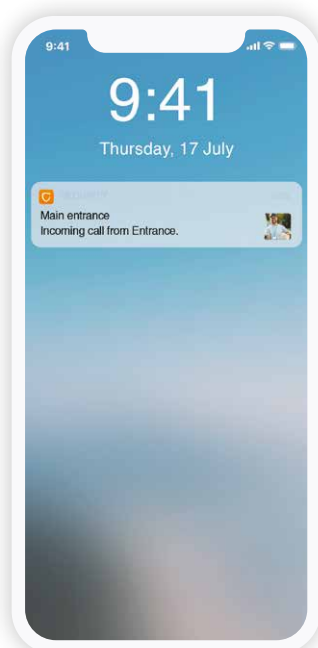

2 WIRES SYSTEM
INTERNAL UNITS
CLASSE 300EOS with Netatmo

Security enhancement with integration of Netatmo devices

Video door entry system and security. Together.

Video door entry system



Main entrance
Incoming entrance call.

Security



Secondary entrance and interiors
Smart Outdoor Camera with Siren and movement detection. Smart Indoor Camera with face recognition.

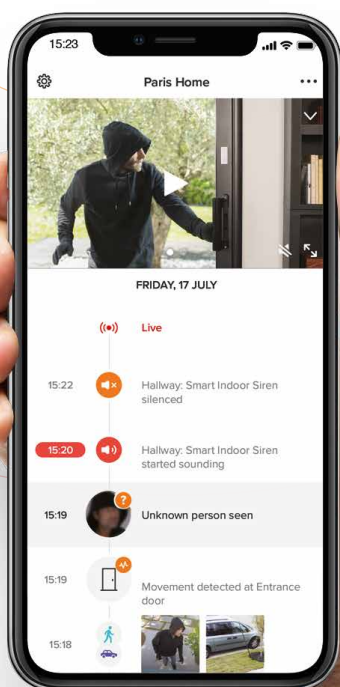

A single App with an intuitive home page. It allows you to answer video door entry calls, activate the door lock and view images from Netatmo smart outdoor and indoor cameras.



Professional opportunity: offer your services as an installer of simple smart security systems.
Business opportunities: access to a catalogue of smart and easy-to-install security devices.

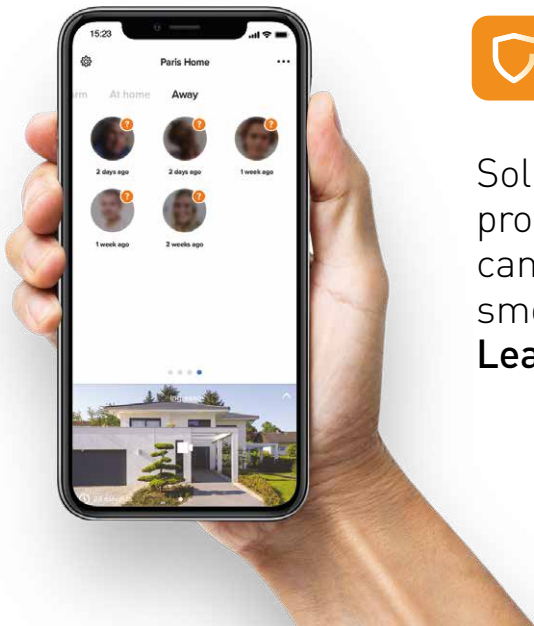

Home + Security
 The best App for a safe home.

Solutions for a smart and complete protection of your home: security cameras, alarms, opening sensors, smoke detector...

Leave your home without worries.

WITH
Netatmo

Examples of Netatmo solutions natively integrated in the Home + Security App



Smart Outdoor Camera



Smart Outdoor Camera with Siren



Smart Indoor Camera



Smart Door and Window Sensors



Smart Video Doorbell



Smart Indoor Siren



Smart Smoke Alarm



Smart Carbon Monoxide Alarm

2 WIRES SYSTEM
INTERNAL UNITS
CLASSE 300EOS with Netatmo



The first video internal unit with built-in Alexa

Enjoy the full Alexa experience
interacting with all its functions, such as:
Custom routines - Play Music - Smart Home
To set the clock alarms - Memos and
video door entry functions.



Add any compatible “works with Alexa” devices, to offer your customers an increasingly Smart home.



“Alexa, open the gate”



“Alexa, answer the call”



“Alexa, I go out”

NOTE: Alexa is not available in all languages and Countries.
Alexa features and functionality may vary by location.

2 WIRES SYSTEM INTERNAL UNITS CLASSE 300EOS with Netatmo

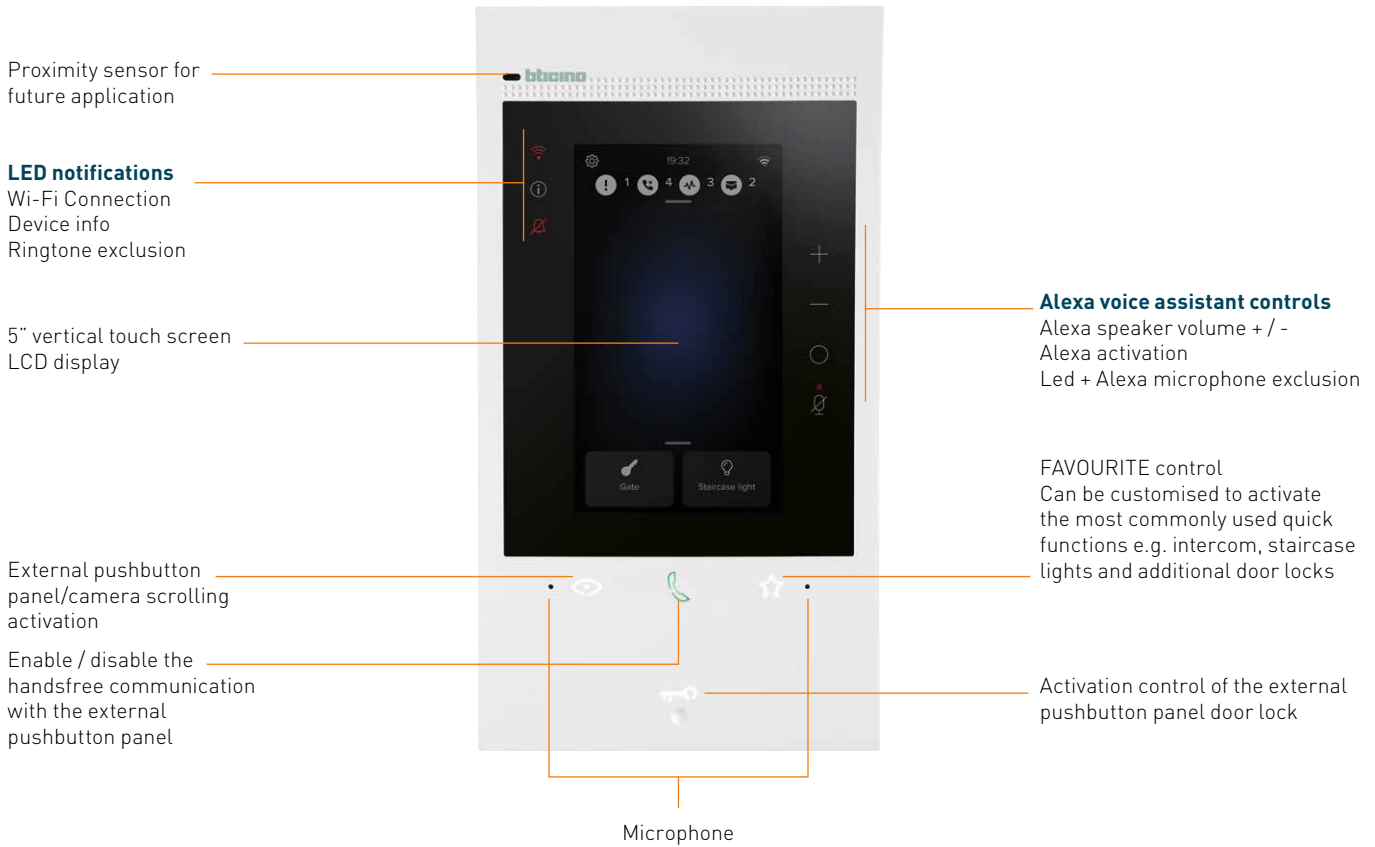

Back view

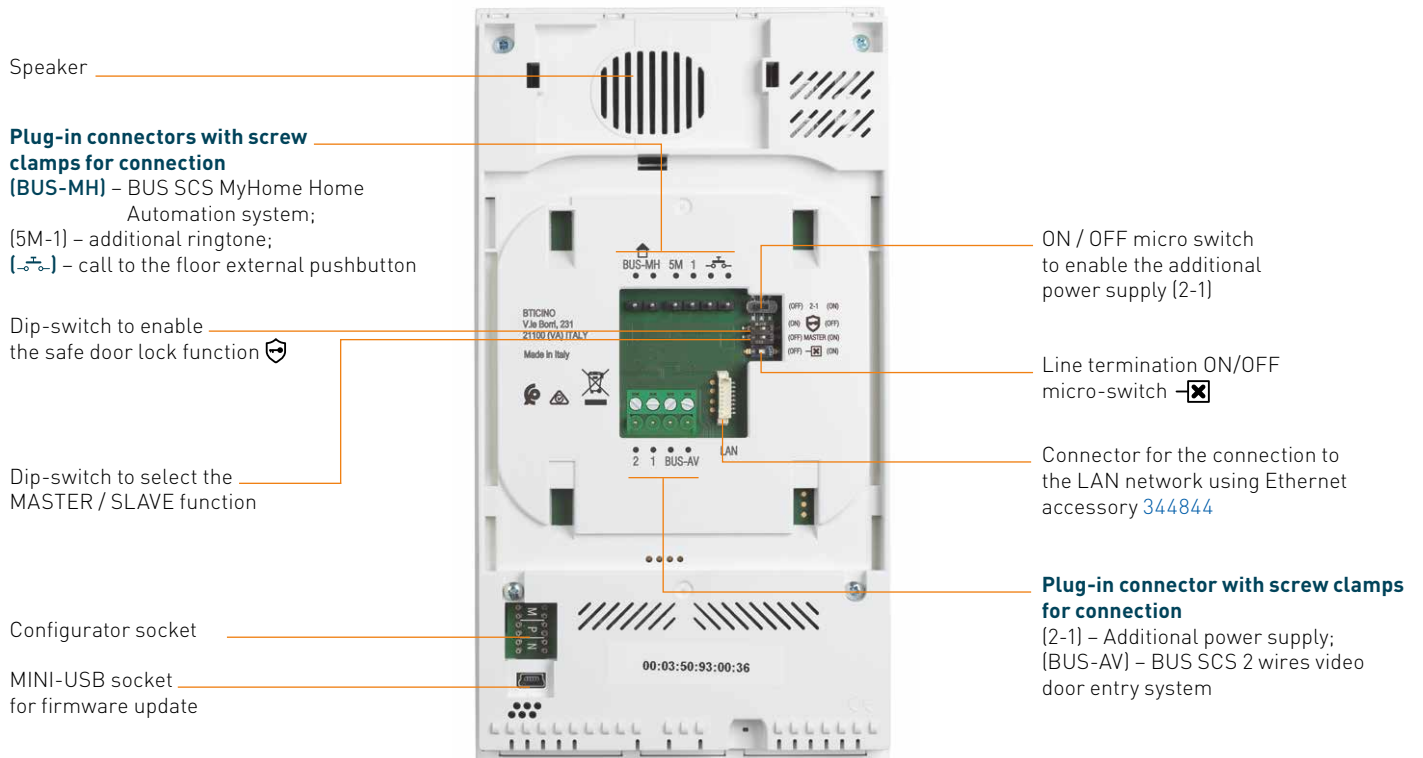



INTERNAL UNITS

CLASSE 300EOS with Netatmo



344842



344884



344844



346020

Item	CLASSE 300EOS WITH NETATMO connected video internal unit –white finish
344842	<p>2 wires/Wi-Fi handsfree connected video internal unit white finish with built-in Amazon Alexa voice assistant, 5" vertical touch screen LCD display and video door entry answering machine. Integrated SCS Server for managing MyHOME wired systems. It can be used alternatively to the SCS Server DIN Item MhServer 1. It has a physical key for door lock release and capacitive keys for the control of the main video door entry functions: handsfree communication, entrance panel activation / camera scrolling and Favourite key (can be configured to activate the quick actions most frequently used – e.g. additional door locks, staircase light control, intercom). There are notification LEDs for:</p> <p>Wi-Fi network connection status, info / notifications and call exclusion. It is possible to easily interact with the built-in Alexa voice assistant, either using the dedicated capacitive keys or with your voice, and activate several functions, such as the video door entry functions, Smart Home, scenarios, reminders etc. Using the touch display, it is possible to access the notification list, as well as your favourite door entry, security and Smart Home controls (if any). The device must be configured by physically connecting the configurators or using the menu, which will give better possibilities of customisation of associated functions and texts. Thanks to the Wi-Fi connection, you can associate the video internal unit to the Home + Security App (available for Android and iOS). The App allows to use the main video internal unit functions (receiving calls, door lock release, display of the event timeline and activation of the entrance panel/camera cycling). Through the Home + Security App, it is also possible to manage the products of the Netatmo security range (outdoor and indoor cameras, door and window sensors, indoor siren and smoke detector). This allows you to quickly and easily create a Smart security system. Wall mounted installation using the supplied bracket. Possibility of Wi-Fi connection or using RJ45 ethernet cable with the dedicated accessory 344844.</p>

Item	CLASSE 300EOS WITH NETATMO connected video internal unit – black finish
344884	Same as 344842 but in Black finish.
Ethernet accessory	
344844	Accessory cable for the wired connection of the Classe 300EOS video internal unit using an RJ45 Ethernet cable. To be purchased separately.
2 DIN additional power supply	
346020	Additional 2 DIN power supply to be used to supply the connected CLASSE 300EOS video internal units (344842 - 344884) locally, when required.



2 WIRES SYSTEM
INTERNAL UNITS
CLASSE 100



Classe 100 X16E
with Netatmo

Now the standard is connected

BTicino renews the range of Classe 100 indoor units by introducing Wi-Fi connectivity in the standard video door entry system offer. The result is a range of video and audio indoor units with a modern and elegant design, capable of meeting all installation needs.



Built-in connectivity for constant connection with the home.

22
apt

Up to **22 apartments** without dedicated power supply.

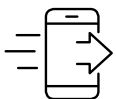

Immediate association with the **Home + Security App**.



Ideal for the refurbishment of old door entry systems.



No extra work for the installer; easier to use for the end user.



After being connected to Classe 100X, the smartphone becomes an "additional virtual video indoor unit" that can be used to answer calls, activate the opening of the door locks and activate the system cameras.



Always aware with the Home + Security App



Home + Security

The best App for a safe home

Alerts and notifications for incoming calls, motion and people detection, event information and door lock management with a simple and intuitive interface.





Answer the calls,
activate the electrical door locks,
activate the cameras and display
the timeline of the events

Manage up to 20 homes
with your single account



Home + Security



Incoming call
Receive notification
when someone
is calling

See who's calling
Answer the call and
open the gate for
the courier

Check the events
Check who called
you thanks to the
event timeline

Quick actions
- Activate the electrical door locks
- Activate the timed staircase lights
- Call home / Intercom
- Activate the cameras

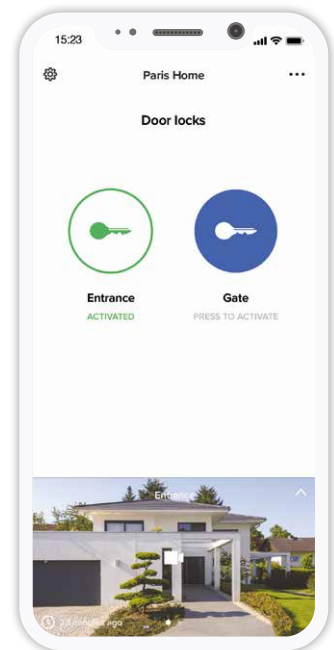
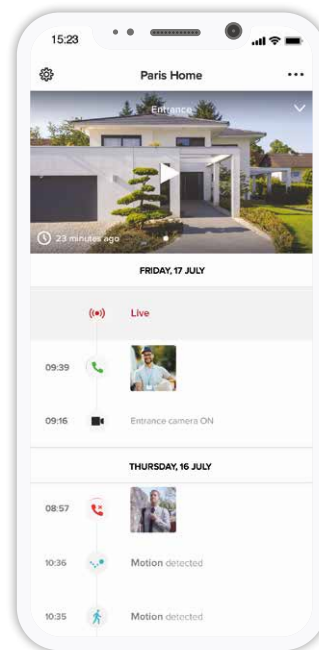
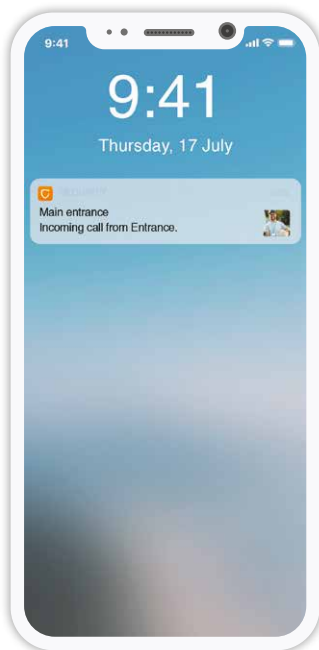

2 WIRES SYSTEM
INTERNAL UNITS
CLASSE 300EOS with Netatmo

Security enhancement with integration of Netatmo devices

Video door entry system and security. Together.

Video door entry system



Main entrance
Incoming entrance call.

Security



Secondary entrance and interiors
Smart Outdoor Camera with Siren and movement detection. Smart Indoor Camera with face recognition.

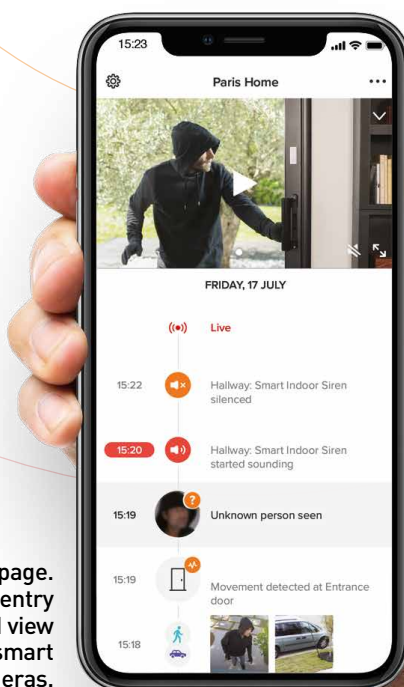

A single App with an intuitive home page. It allows you to answer video door entry calls, activate the door lock and view images from Netatmo smart outdoor and indoor cameras.





Professional opportunity: offer your services as an installer of simple smart security systems.
Business opportunities: access to a catalogue of smart and easy-to-install security devices.

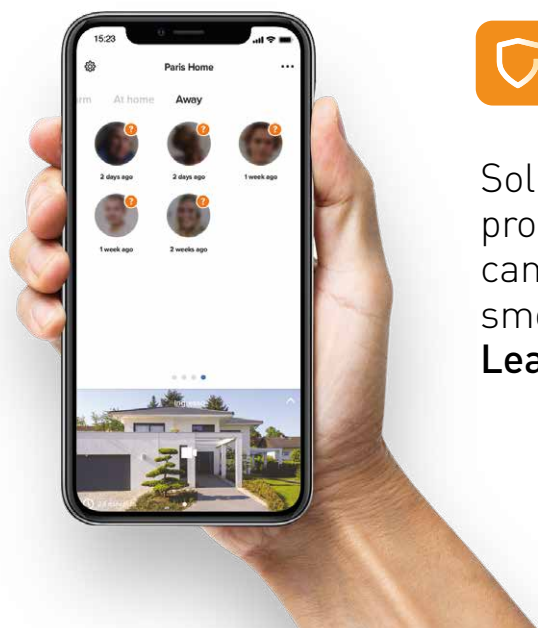

Home + Security
The best App for a safe home.

Solutions for a smart and complete protection of your home: security cameras, alarms, opening sensors, smoke detector...
Leave your home without worries.

WITH
Netatmo

Examples of Netatmo solutions natively integrated in the Home + Security app



Smart Outdoor Camera



Smart Outdoor Camera with Siren



Smart Indoor Camera



Smart Door and Window Sensors



Smart Video Doorbell



Smart Indoor Siren



Smart Smoke Alarm



Smart Carbon Monoxide Alarm

2 WIRES SYSTEM

INTERNAL UNITS

CLASSE 100

Features and functions

Classe 100 X16E with Netatmo	Classe 100 V16E	Classe 100 V16B	Classe 100 V16M	Classe 100 A16E	Classe 100 A16M
					
344682	344672	344652	344625	344282	344292

FEATURES						
LCD colour display	5 inches	5 inches	5 inches	4.3 inches		
Handsfree	●	●	●		●	
Finish	white	white	white	white	white	white
Available in KIT	364614	364612	364613		364232	364231
Installation	wall / table	wall / table	wall / table	wall	wall / table	wall / table

AVAILABLE FUNCTIONS FROM AUDIO / VIDEO INDOOR UNIT						
Door lock activation	●	●	●	●	●	●
Staircase light activation	●	●	●	●	●	●
EP / Scrolling activation	●	●	●	●	●	●
Intercom (1)	●	●	●	●	●	●
Inductive loop (2)	●	●				
Floor call	●	●	●	●	●	●
No. of configurable keys	4	4	1	1	4	4
No. of available ringtones	20	16	16	16	16	16
Professional Studio (Office)	●	●			●	●
Wi-Fi connectivity	●					





AVAILABLE FUNCTIONS FROM HOME + SECURITY APP						
Answer video door entry system calls	●					
Door lock activation	●					
Staircase light activation	●					
Intercom call from smartphone to video indoor unit	●					
Management Netatmo Security devices (smoke sensor , burglar alarm siren , opening sensor	●					
EP / Scrolling activation	●					

1) Audio call, max. 3 minutes, between indoor units of the same apartment/different apartments
 2) Use by people wearing hearing aids fitted with T selector





Front view

Touch sensitive controls

-  Door lock activation
-  Entrance panel/camera scrolling activation
-  Staircase light activation
-  Customisable controls for the activation of accessory functions (e.g. intercom, activation of additional door lock, various activations)

LED notifications

-  Wi-Fi Connection
-  Ringtone exclusion

Physical control

Enable the handsfree communication

Physical control

Disable the handsfree communication



Tactile guide

Rear view

Plug-in connectors with screw clamps for connections

USB mini socket for firmware update

Adjustment and programming menu access and navigation joystick

ON / OFF micro switch to enable the Safe Door Lock function

Line termination ON/OFF micro-switch

Configurator socket

ON / OFF micro switch to enable the additional power supply

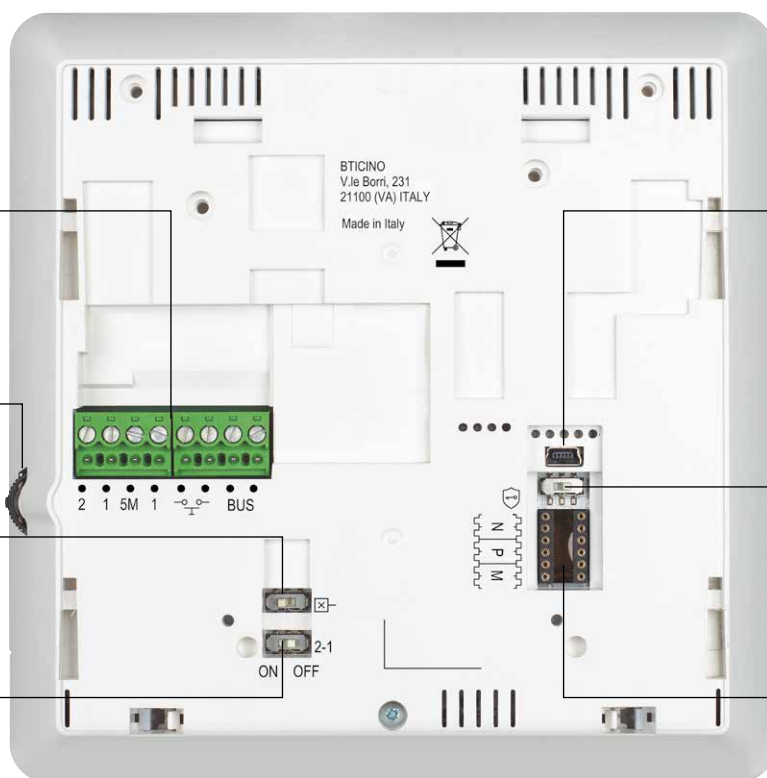

2 WIRES SYSTEM

INTERNAL UNITS

CLASSE 100



344682



344672



344652



344625



App Home + Security

Item	CLASSE 100X16E connected video indoor unit
344682	<p>Classe 100X16E with Netatmo 2 wires / Wifi handsfree connected video internal unit with inductive loop and 5" colour LCD display. It has 2 physical keys for the control of the main video door entry functions – answer and end a call – it has 3 touch keys for the control of the main functions – door lock release, staircase light control and entrance panel activation/scrolling – there are further 4 configurable touch keys that perform different functions – e.g. staircase light control, intercom, additional door lock activation, generic activations. The device has a side lever to adjust: colour, brightness and display contrast, audio volume, call tone volume and Wifi configuration. There are call exclusion notification LEDs and Wifi. Also, thanks to the Wifi connection, you can associate the video internal unit to the Home + Security App (available for Android and iOS). You can manage the main video internal unit functions (receiving calls, opening the door lock, activating the entrance panel/scrolling, FWR updating and additional activations) from the App. Through the Home + Security App it is also possible to manage the products of the Netatmo security offer (Outdoor and Indoor cameras, door and window sensors, internal siren and smoke detector). This allows you to quickly and easily create a Smart security system. The installation can be made to the wall using the bracket supplied or using table support accessories (2 x 344692) – to be purchased separately. The device, also equipped with the professional studio (office) function, must be configured.</p>

Item	CLASSE 100V16B video indoor unit
344652	<p>2 WIRES handsfree video indoor unit with 5" colour LCD display. The device has 2 physical keys for the control of the main video door entry functions – answer and end a call – and 3 touch keys that allow the door lock release, the entrance panel activation/scrolling and the customisation of a most frequently used quick action – e.g. staircase light control, intercom, additional door lock activation, generic activations. The device has a side lever to adjust: colour, brightness and display contrast, audio and call tone volume. There is a call exclusion notification LED. The installation can be made to the wall using the bracket (supplied) or using table support accessories (2 x 344692) – to be purchased separately. The device must be configured.</p>

Item	CLASSE 100V16E video indoor unit
344672	<p>2 WIRES handsfree video indoor unit , with inductive loop and 5" colour LCD display It has 2 physical keys for the control of the main video door entry functions – answer and end a call – it has 3 touch keys for the control of the main functions – door lock release, staircase light control and entrance panel activation/scrolling – there are further 4 configurable touch keys that perform different functions – e.g. intercom, additional door lock activation, generic activations. The video indoor unit has a side lever to adjust: colour, brightness and display contrast, audio and call tone volume. There is a call exclusion notification LED. The installation can be made to the wall using the bracket (supplied) or using table support accessories (2 x 344692) – to be purchased separately. The device also has Professional Studio (Office) function and must be configured.</p>

Item	CLASSE 100V16M video indoor unit
344625	<p>2 WIRES video indoor unit with handset and 4.3" colour LCD display, suitable for wall mounting installation (bracket support included). The device has three touch keys that allows : door lock release, entrance panel camera activation/scrolling and customization of an auxiliary function – e.g. additional door lock activation, additional camera activation. Side easily accessible and independent regulations for : call volume / ringtone exclusion (with notification LED), display colour and brightness. The handset has magnets for easy holding.</p>

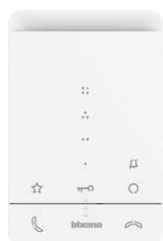

344282



344292



344692



336803



336982



346020

Item	CLASSE 100A16E handsfree audio indoor unit
344282	<p>2 WIRES handsfree audio indoor unit for wall mounted or table installation.</p> <p>It has 2 physical keys for the control of the main functions – answer and end a call – and has 3 touch keys for the control of the main functions – door lock release, staircase light control and entrance panel activation/scrolling – there are further 4 configurable touch keys that perform different functions – e.g. intercom, additional door lock activation, generic activations. The device has a side lever to adjust the audio volume and call tone and a call exclusion notification LED.</p> <p>The installation can be made to the wall using the bracket (supplied) or using table support accessory (1 x 344692) – to be purchased separately. The device also has Professional Studio (Office) function and must be configured.</p>

Item	Accessories - table support - cable - sockets
344692	Table support accessory for CLASSE 100 audio and video hands-free indoor units.
336803	8-way cable with connector for tabletop support connection.
336982	<p>White Livinglight series 8-pole plug for the connection of the 336803 cable in tabletop installations.</p> <p>The socket is available also in the following finishings: - LIVINGLIGHT (336983 - 336984); - AXOLUTE (349414 - 349415 - 349418); - MATIX (336985).</p>
2 DIN additional power supply	
346020	Additional 2 DIN power supply to be used for the local power supply to connected CLASSE 100x16E (344682) video indoor units in multi-family systems in complexes with more than 22 apartments.

CLASSE 100A16M audio indoor unit with handset	
344292	<p>2 WIRES audio indoor unit with handset for wall mounted or table installation. It has 3 touch keys for the control of the main functions – door lock release, staircase light control and entrance panel activation/scrolling – there are further 4 configurable touch keys that perform different functions – e.g. intercom, additional door lock activation, generic activations. Ringtone volume adjustment (with call exclusion) using the appropriate selector. The installation can be made to the wall using the bracket (supplied) or using table support accessory (1 x 344692) – to be purchased separately. The device also has Professional Studio (Office) function and must be configured.</p>

2 WIRES SYSTEM

INTERNAL UNITS

Netatmo safety devices

Home + Security App



NOC - PRO



NOC -S- PRO



NOC-S-W-PRO



NSC - PRO



NBU - AS - PRO



DTG - PRO

Item	Smart outdoor camera
NOC-PRO	Smart outdoor safety camera with detection of people, animals and vehicles. Aluminium single monobloc construction. Ultra-resistant glass and plastic, protection against UV rays. Video sensor: 4MP. Resolution: Full HD 1080 p. Coding: H.264. Long-range detection: up to 20 m. Field of view: 100°. 8x digital zoom for videos. Video live microphone. LED spotlight: 12 W, variable intensity. Infrared night vision: 15 m. Encryption protected access to the smartphone using the Home + Security App. Weather resistant: designed for outdoor use (HZO protection).

Item	Smart indoor camera
NSC-PRO	Smart indoor safety camera with people detection consisting of an aluminium monobloc unit. Video sensor: 4MP. 130° panoramic view for a wider coverage. High quality video with Full HD 1080 p viewing. Guaranteed day and night protection with infrared vision, for comfortable viewing even in total darkness. Recording only in case of intrusion, in respect of the privacy of the family. Encryption protected access to the smartphone using the Home + Security App. Declaration of conformity and FCC declarations. Open-source compatibility. It has to be connected to an electric socket with the supplied AC adapter.

Item	Smart outdoor camera with siren
NOC-S-PRO	Smart outdoor safety camera with detection of people, animals and vehicles. Equipped with 105 db alarm siren. Aluminium single monobloc construction. Ultra-resistant glass and plastic, protection against UV rays. Video sensor: 4MP. Resolution: Full HD 1080 p. Coding: H.264. Long-range detection: up to 20 m. Field of view: 100°. 8x digital zoom for videos. Video live microphone. LED spotlight: 12 W, variable intensity. Infrared night vision: 15 m. Encryption protected access to the smartphone using the Home + Security App. Weather resistant: designed for outdoor use (HZO protection).
NOC-S-W-PRO	Features like NOC-S-PRO. White finish.

Item	Smart video alarm system
NBU-AS-PRO	Smart video security alarm system consisting of 1 smart indoor camera, 1 smart indoor siren and 3 smart door and window opening sensors. The products can be easily configured and associated using the Home + Security app. The smart video alarm system activates and deactivates automatically, has pre-recorded sounds to simulate a presence in the home, respects the privacy of the family and activates a 110 dB sound in case of intrusion.

Item	Smart door and window sensors
DTG-PRO	Smart opening sensors for doors and windows ideal for safety. Sensors with waterproof monobloc construction, vibration/motion detection and open/closed status. Power supply with 2 AAA-type batteries included in the package. They only work with the smart indoor camera (sold separately): radio link between the sensors and the camera. Declaration of conformity and FCC. Open-source compatibility. Can be controlled and managed remotely with Home + Security app.



NDB - PRO



NSA - PRO - EU



NIS - 01 - PRO



NCO - PRO

Item **Smart video doorbell**

NDB-PRO Smart video doorbell for outdoor installation. Allows you to receive a video call on your smartphone when someone rings the doorbell. Equipped with Camera: 2 megapixels, 5x digital zoom. HDR function of automatic adaptation to lighting conditions. Infrared night vision even in conditions of total absence of brightness. Video: Full HD 1080 p, portrait format 9:16. Field of view: 140° diagonal. Sound: high-quality speaker and microphone. Night vision: Infrared LED. Operating temperature: -10° to 40° C. Weather resistant: HZO protection and IP44 certification. Power supply: 8-24 VAC & 230 VAC; minimum 8 VA. Local storage on microSD memory card and optional storage on Dropbox or FTP server. MicroSD card up to 32 GB (class 10). Data protection with encrypted connection for the highest level of privacy. Requirements: high speed internet access. The minimum required upload and download speed is 25 KB/s. Hotspots are not supported. Wireless specifications: Wi-Fi 802.11 b/g/n (2.4 GHz), Open/WEP/WPA/WPA2-personal. Operation via Home + Security app (iOS 10 required minimum - Android 5.0 required minimum). Compatible with Apple HomeKit, Google Assistant and Amazon Alexa. www

Item **Smart smoke alarm**

NSA-PRO-EU Smart Smoke Alarm with 85 dB alarm, high performance photoelectric sensor, average coverage 50 m². When it detects the presence of smoke, it activates its 85-decibel alarm and immediately alerts you to your smartphone. It is equipped with a 10-year battery - the maximum lifetime for all smoke detectors. The Self-Test feature checks if the Smart Smoke Alarm is functioning correctly. If it detects a problem, it sends a notification to your smartphone. Reliability guaranteed by CE (EN 14604) and NF certifications. Standalone device, no hub required. Compatible with Apple HomeKit. Operation via the Home + Security app. Requirements: High-speed wireless internet connection needed. Public hotspots not supported. The Smart Smoke Alarm will detect smoke and will sound even if the Wi-Fi isn't configured. However, you will need Wi-Fi to receive smartphone alerts. Wi-Fi 802.11 b/g/n (2.4 GHz), Open/WEP/WPA/WPA2-Personal, Bluetooth Low Energy (BLE).

Item **Smart indoor siren**

NIS-01-PRO Smart indoor siren with 110 dB alarm, pre-recorded sounds and vibration sensor for tamper detection. Battery power supply or with a cable (not supplied) using the USB micro port. It only works with the smart indoor camera and must be installed in the same room: Bluetooth Low Energy (BLE) wireless connection with the smart indoor camera. Declaration of conformity and FCC declarations. Open-source compatibility. Operation using the Home + Security app.

Item **Smart carbon monoxide alarm**

NCO-PRO Smart carbon monoxide alarm / detector for wall installation. It allows to monitor the fuel-burning appliances (boiler, fireplace, wood-burning stove, gas cooker, etc.) by measuring, in real time, the levels of carbon monoxide, which is an invisible, odourless and potentially fatal gas. When it detects the presence of carbon monoxide, it activates its 85-decibel alarm and immediately alerts you to your smartphone. It is equipped with a 10-year battery - the maximum lifetime for all carbon monoxide detectors. The Self-Test feature checks if the Smart Carbon Monoxide Alarm is functioning correctly. If it detects a problem, it sends a notification to your smartphone. Reliability guaranteed by CE (EN 50291) and NF certifications. Standalone device, no hub required. Compatible with Apple HomeKit. Operation via the Home + Security app. Requirements: High-speed wireless internet connection needed. Public hotspots not supported. The Smart Carbon Monoxide Alarm will detect Carbon Monoxide and will sound even if the Wi-Fi isn't configured. However, you will need Wi-Fi to receive smartphone alerts. Wi-Fi 802.11 b/g/n (2.4 GHz), Open/WEP/WPA/WPA2-Personal, Bluetooth Low Energy (BLE).

2 WIRES SYSTEM INTERNAL UNITS SPRINT L2



344242



344232

Item

SPRINT L2 audio handsets

344242 2 WIRE audio handset (without the possibility of fitting with accessories) for audio systems and mixed audio /video systems. Wall mounted installation without the need of accessories. With door lock release key and auxiliary functions key (that can be configured). Ringtone volume adjustable on 3 levels. White

344232 As item 344242 but with call to the floor function

DIMENSIONAL DATA

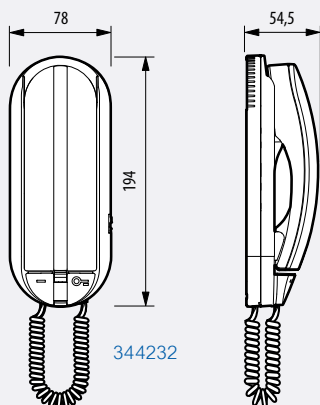

Size in mm



1 Simple and modern design

2 Ringtone volume, adjustable to 3 levels

3 Two pushbuttons:
- door lock release
- available for applications (e.g. control of staircase lights)

Universal analogue audio handset



334262

Item

Universal analogue audio handset

334262 Universal audio handset that can be installed in BTicino analogue (1 + n) and (4 + n) Compatible with most competitors analogue systems. It has a lock release button and it is designed for the installation of 4 buttons accessory (Item 337430) for additional functions. Volume adjustment on 3 levels.



Porter switchboards



346310



346300

- | Item | Switchboard and accessories |
|--------|--|
| 346310 | Switchboard for 2 WIRE audio and video systems. Allows access to various services (video door entry functions, door lock/staircase light management and apartment alarm monitoring) directly from the keypad or via the intuitive icon menu. The switchboard is supplied with an integrated table supporting frame and also features a 7" colour LCD display, receiver and speaker phone, dedicated keys for the main functions and keys which can be configured. The programming can be carried out directly from the device or via PC with TiSwitchBoardDevice software (supplied). The device can manage the phonics of the riser EP (i.e. wired downstream of interface 346851); it cannot however manage the apartment EP (i.e. wired downstream of interface 346850). The use of an additional power supply is recommended. It is possible to connect up to a max. of 16 switchboards (configured from 0 to 15).
WARNING: the switchboard cannot be used in systems with 2 WIRE-IP interface 346890. The new HIERARCHICAL mode is available only with the entrance panels of the following series: Sfera New, Linea 100, Minisfera, Linea 300. |
| 336982 | White 8-way socket for table top installation of switchboard item 346310 |
| 336803 | 8 – Way cable with connector for the table top installation connection. |

- | Item | SOFTSWITCHBOARD software |
|--------|---|
| 346300 | Switchboard software for the management of audio and video door entry system calls. The software (Windows operating system compatible) can be installed on any desktop or laptop PC, and gives the possibility of receiving, managing and transferring the calls from the entrance panel and the handset. It implements home video monitoring, with cyclical display of the cameras, night and day functions, and the possibility of displaying the alarms in the various apartments.
- Supported operating systems: Microsoft Windows XP Service Pack 2, Windows Vista and Windows 7.
- Software required: NET Framework 3.5 or higher |

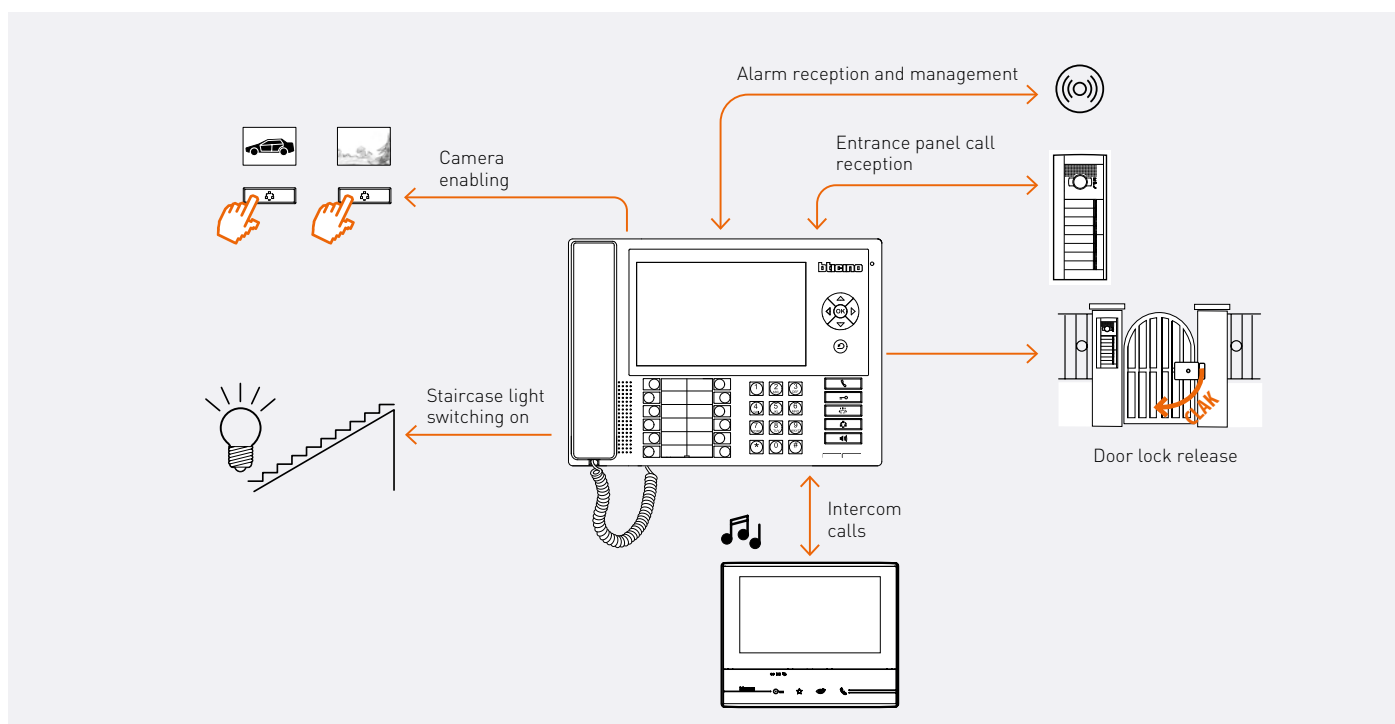



SYSTEM ACCESSORIES RANGE

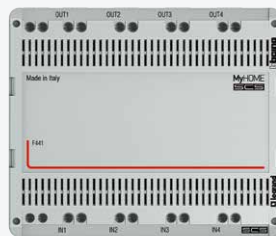
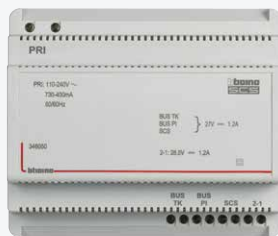



SYSTEM ACCESSORIES

Accessories



346050 SELV



346030 SELV



F441



346850



346851



346040 SELV



346020 SELV

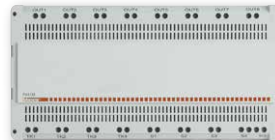

F441M

Item	Power supplies
346050	Power supply for 2 WIRES system in 6 DIN modular enclosure. Power supply 110 – 240 Vac @ 50 – 60 Hz. The output provides two power supplies in very low safety voltage (one on the 3 TK BUS, IU BUS and SCS clamps, one on the 1 - 2 clamp) to be used alternately and NOT at the same time. To be used in audio, video or mixed audio video systems. The video adapter is integrated in the device (item 346830 must not be used). It is therefore possible to avoid the use of the A/V node (F441) or the Multi-channel Matrix (F441M), if three junctions (MAX 2 IU + 1 TK risers or 1 IU + MAX 2 TK risers) are not exceeded in total from the clamps. It can also be used as additional power supply (1 - 2 output) for the local power supply of the preset internal units or entrance panels (in this case it is not possible to use other outputs). The device is electronically protected against overload and short circuit. It is a SELV double insulation safety device. The installation must be made in compliance with current regulations. The device must not be configured. WARNING: the (IU BUS), (TK BUS) and (SCS) outputs can be used at the same time respecting the total maximum absorption of 1.2 A. WARNING: Disconnect the power supply for 5 minutes after overload or short circuit.
346040	Power supply for 2 WIRES audio systems in 6 DIN modular enclosure. Power supply 110 – 240 Vac @ 50-60 Hz. The output provides 26 Vdc low rated voltage, and a maximum rated current of 600 mA and it is protected on the PRI side (with fuse) against overload and short circuit. It is a SELV double insulation safety device.
346030	Mini power supply with integrated video adapter to make small 2-WIRES video systems (intercom). 2 DIN modular enclosure. Power supply 230 Vac @ 50-60 Hz. The output provides 27 Vdc continuous low voltage, with maximum current of 600 mA and it is protected on the PRI side (with fuse) against overload and short circuit. It is a SELV double insulation safety device.
346020	Additional power supply to be used to supply the set up entrance panels and internal units locally. 2 DIN modular enclosure. Power supply 230 Vac @ 50-60 Hz. The output provides 27 Vdc continuous low voltage, with maximum current of 600 mA and it is protected on the PRI side (with fuse) against overload and short circuit. It is a SELV double insulation safety device.

Item	Video mixers
F441	Audio video node in 6-DIN modular enclosure set up with 4 input terminals and 4 output terminals. Can connect up to 4 source devices (entrance panels or cameras) in input and up to 4 2-WIRES video risers in output. The device must be used with the system power supply 346000. It must be used as an alternative to the audio video adapter 346830
F441M	Multi-channel matrix in 10 DIN modular enclosure. Set up for the connection of video entry system entrance panels, cameras and sound system sources in input and internal units and amplifiers in output. 4 inputs are dedicated to entrance panels/cameras and 4 to the sound system sources. It can be used to create multi-channel sound systems. The device must be used with the system power supply 346000. In the systems it replaces the video adapter 346830 and the audio video node F441
346850	System interfaces Apartment interface in 4 DIN modular enclosure. Can interface a dedicated apartment video door system with local CCTV, sound system and control of the Home automation applications to a 2-WIRES riser. The device must be configured using physical configurators
346851	System expansion interface in 4 DIN modular enclosure. Can double the length of the entrance panel-internal unit line, create risers with independent sound and expand the performance of the apartment system. The device must be configured using physical configurators

2 WIRES SYSTEM SYSTEM ACCESSORIES

Accessories

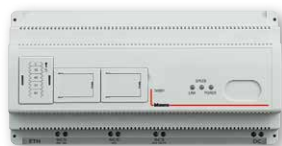

346891



346260



346210



346841



347400



346870



346993



346250



3499



354000

Item	Interfaces with other BTicino systems
346891	Can make very large mixed 2 WIRES/IP systems with a large number of devices, thanks to the creation of an IP backbone with 2-WIRES risers. The device must be configured using physical configurators or using the software
346150	8/2-WIRES interface in 6 DIN modular enclosure. Can make mixed video door entry systems (8-WIRES digital backbone/2-WIRES risers). The device must be configured using physical configurators
349410	Analogue/2 WIRES interface in 4 DIN modular enclosure. Can interface a dedicated apartment 2-WIRE video door entry system with cameras and control of the MyHOME applications to an analogue riser, digital 8-WIRES, audio TERSYSTEM and VIDEOPORTER 2000.
	DIN actuators
346210	Relay actuator in 2 DIN modular enclosure. Can switch on lights, open gates, repeat the call on bells (MOD=SLA) or control other devices from the video internal units. The device must be configured using physical configurators
346230	Door lock relay actuator in 2 DIN modular enclosure. Can supply power and activate an electrical door lock. The device must be configured using physical configurators
346260	Timed door lock relay actuator in 4 DIN modular enclosure. Can switch on lights, open gates or manage electro-magnetic door locks, timed door opening and door lock status (with NC contact). The device must be configured using physical configurators

Item	Devices in basic enclosure
346841	Floor shunt with 4 outputs Can make 2-WIRES video door entry systems with star wiring distribution. The device automatically adapts the video signal. Its small size means it can also be placed inside the flush-mounted box
346833	Call to the floor interface. By connecting a traditional pushbutton, the following functions will be possible: general call to the floor, addressed call to the floor, staircase lights on, and door lock release (specific actuator needed) and association of the video image to the call to the floor. The device must be configured using physical configurators
347400	Interface for the conversion of the coaxial signal into a 2 WIRES BUS signal. It can be used to connect to the BUS of the 2 WIRES video door entry system a camera with coaxial video output powered at 12 Vdc, with maximum absorption 150 mA and 1 Vpp video output (75 Ω). The device must be configured using physical configurators
	Wiring accessories
346870	2 WIRES video amplifier. In video systems wired using non-twisted wires, where the distance between the entrance panels and the internal unit exceeds 50 metres, it enables increasing such distance to up to 100 metres
346250	Relay module for gate opening to be used with LINEA 2000, LINEA 3000, MINISFERA and SFERA pushbutton panels. Can open door locks (NOT managed by BUS) by means of the entrance panel
3499	Line terminator. To be used to terminate the riser or apartment line, when the last installed device is not fitted with line closing micro switch
354000	Flat cable for the connection of several SFERA NEW and SFERA ROBUR pushbutton modules. Length 470 mm



346991



336904
336905



3515



3501/1



3501K

Item	Universal speaker unit and expansion module
346991	The universal speaker unit can be used to install the 2 WIRES audio system in new or refurbished systems, where pushbutton panels of other manufacturers are present or required (mail boxes, patterned brass, compact sheet metal units, etc.), preset for a traditional speaker module (e.g. 2659N). The universal speaker unit has, as base, contacts for the connection of 8 call keys; to make systems with more keys (up to 56 using the 346000 power supply and up to 24 with the 346010 power supply one or more key expansion modules must be used (1 every 8 pushbuttons).
346992	Expansion module for connecting more than 8 call keys to item 346991 - max. 6 modules (56 calls max.) with power supply 346000. Max. 2 modules (24 calls max.) with power supply 346010
Cable for systems	
336904	Specific cable for 2 WIRES video door entry applications with 2 twisted conductors. It can be installed in underground piping, in accordance with standards (CEI 20-13 and CEI 20-14). It ensures the best performance in video systems (higher distance between EP and Handset when compared with other cables). 200 m coil
336905	Specific cable for BUS / SCS unshielded, consisting of a white outer sheath and 2 flexible conductors twisted together with a cross section of 0.50 mm ² . Halogen-free low-toxicity cable; ideal for applications in environments where greater regard is required for safety in the event of fire (halogen free) . 400 V insulation. Compliant with standards: EN 50575 EN60811, EN50289, EN50290, EN60228, 50265-2-1, EN50395, EN50396. Cable not suitable for burial. Coil length 200 m. Fire reaction class according to CPR regulation: Ccas1b, d1, a1.
Spare part terminal/clamp	
3515	Spare part terminal/clamp for BUS connection of the predisposed devices

Item	Configurators (package of 10 pieces)
3501/0	Configurator 0
3501/1	Configurator 1
3501/2	Configurator 2
3501/3	Configurator 3
3501/4	Configurator 4
3501/5	Configurator 5
3501/6	Configurator 6
3501/7	Configurator 7
3501/8	Configurator 8
3501/9	Configurator 9
3501/JMP	Configurator JMP

Item	Configurator kit
3501K	Configurator kit consisting of: - 10 pieces for each type of configurator from 0 to 9 - 2 blue removable 8-clamp connectors - 2 green removable 2-clamp connectors - 1 configurator connection tool (3502) - 1 plastic screwdriver

2 WIRES SYSTEM WIRING DIAGRAM EXAMPLES

Audio system

Example of multi-family audio system

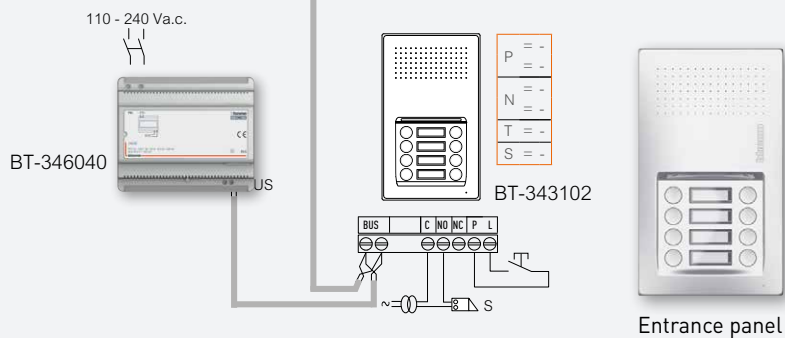
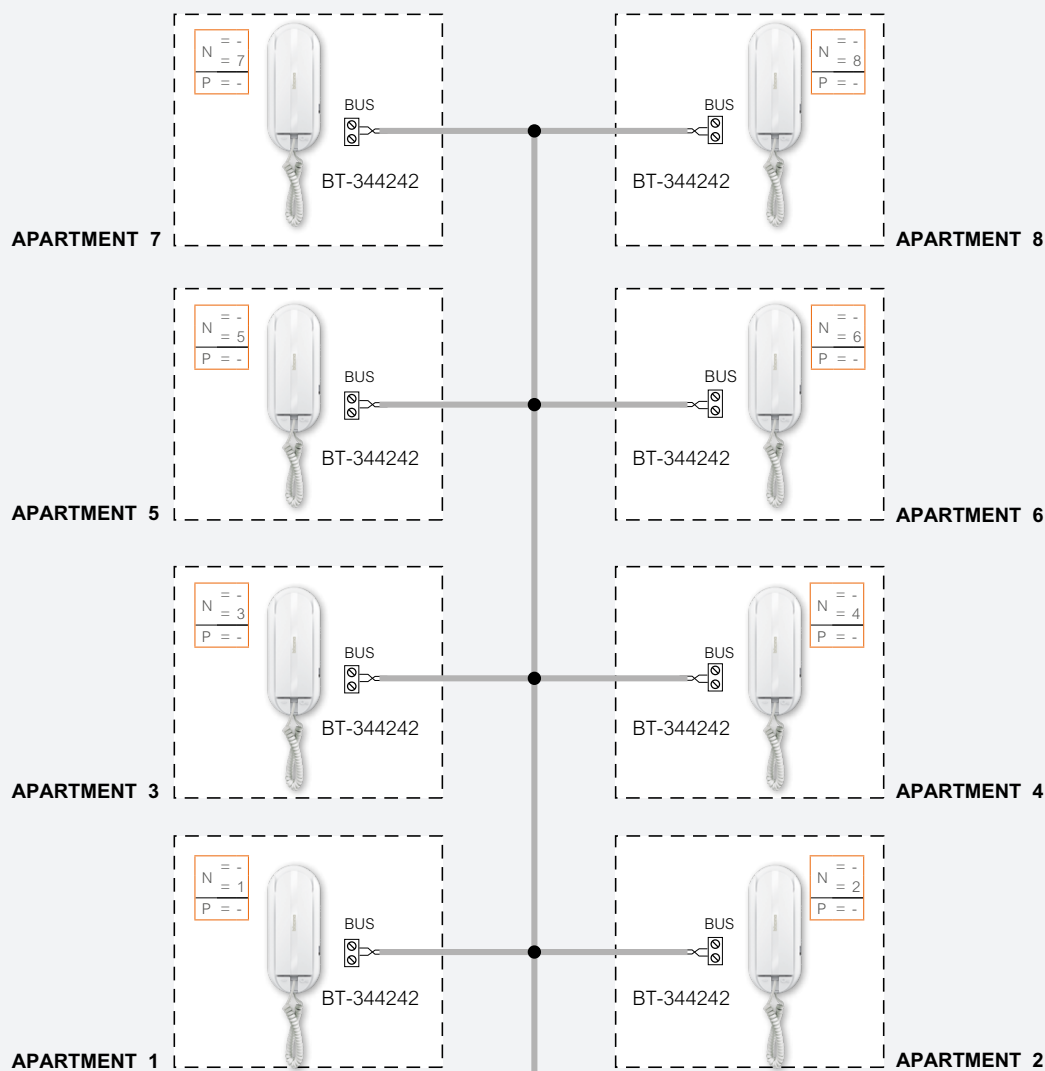

Video system

Example of multi-family video system

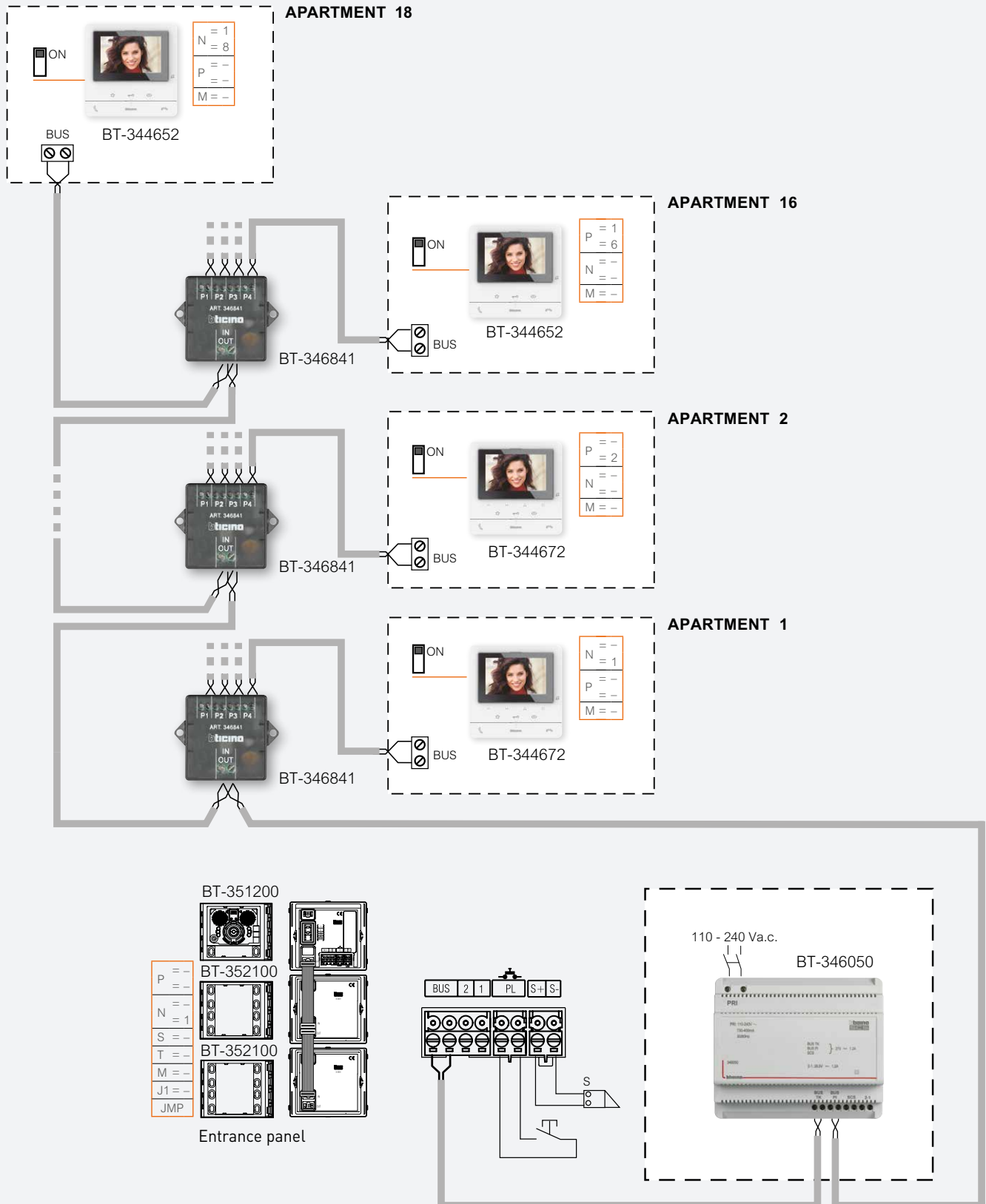

IP SYSTEM

Video door entry system

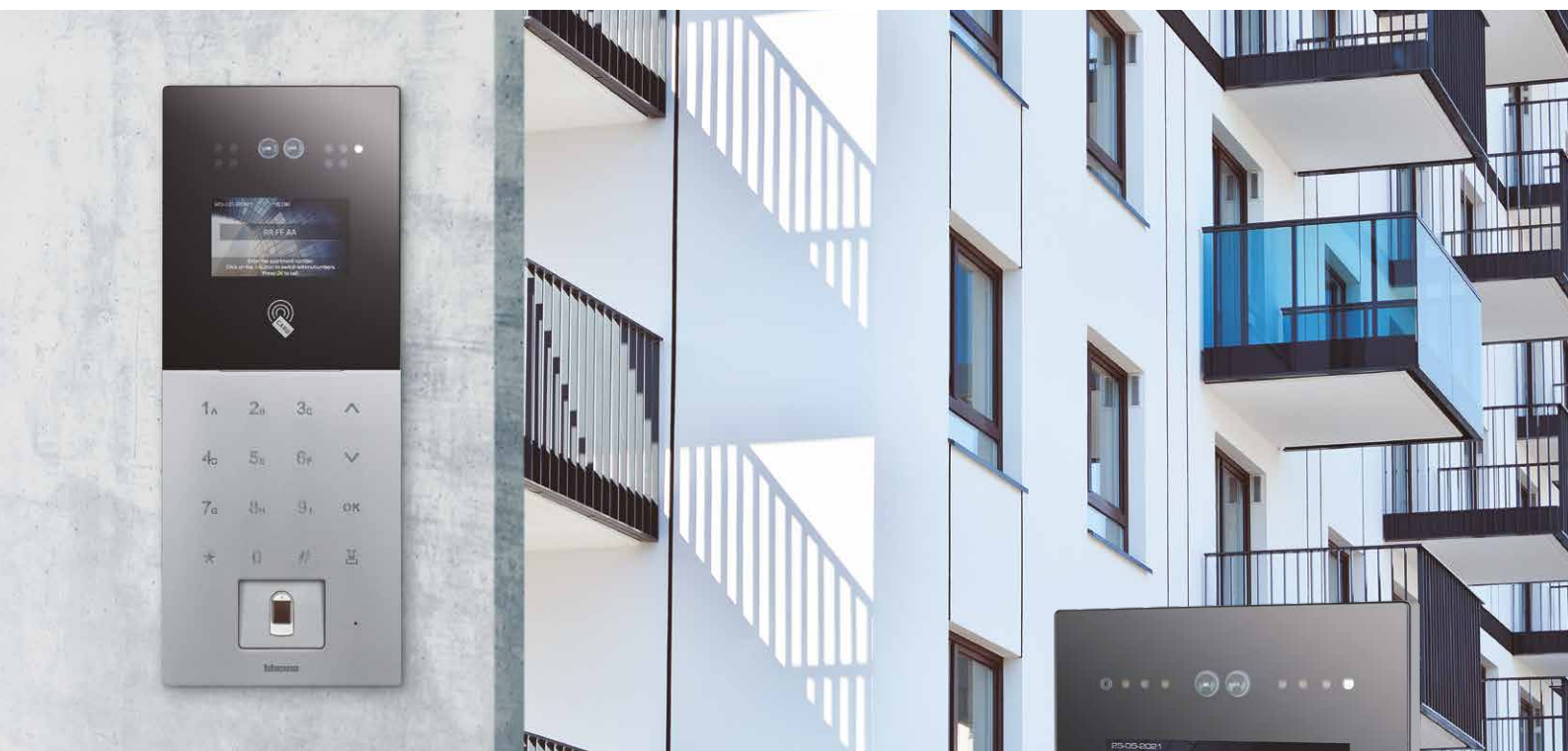

IP SYSTEM FOR THE BEST PERFORMANCE

The perfect solution for large residential complexes with a high number of apartments, able to guarantee high performance, long distances and high video signal quality.



reddot winner

The "Red Dot" is a highest design quality award. The international jury only awards this sought-after seal of approval to products of outstanding design.



Entrance panel



Video indoor unit



Guard station

Wide range of products with flexible and scalable solutions to satisfy every building needs.

MAIN PERFORMANCES AND FUNCTIONALITIES

Multichannel: for simultaneous conversations (no busy lines);

High definition video quality: up to 1280 x 720;

Technology: IP protocol (SIP/TCP);

Cables: FTP and UTP (CAT5 - CAT5E - CAT6) - Fiber optic

Configuration: easy and quick configuration with dedicated software;

Integration: Onvif IP Cameras, Lift control, Alarm sensors;

App Home + Security: incoming calls answering and door locks activation by smartphone.

CALL THE APARTMENT ANY WAY YOU LIKE



- 1. STANDARD CALL**
Area-Building-Riser
Floor-Apartment
- 2. ALPHANUMERIC CALL**
Create codes
with numbers and letters
- 3. ADDRESSBOOK**
With contact list
(touch displays only)

ACCESS THE BUILDING IN SEVERAL WAYS



FACE RECOGNITION



FINGERPRINT



RFID CARD AND BADGE

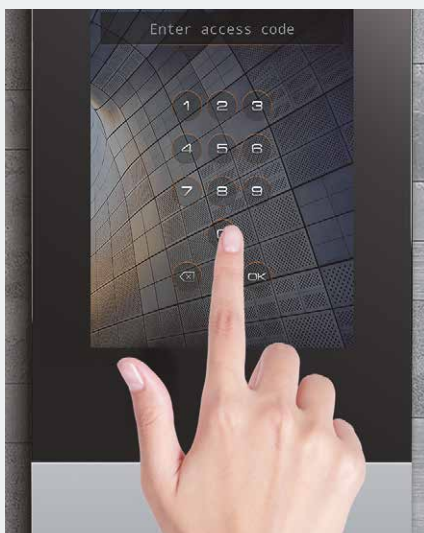

ACCESS CODE

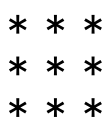

SMARTPHONE

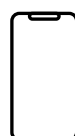



ALWAYS AWARE WITH THE **HOME + SECURITY APP**

THE BEST APP FOR A SAFE HOME

Alerts and notifications for incoming calls, motion and people detection, event information and door lock management with a simple and intuitive interface.

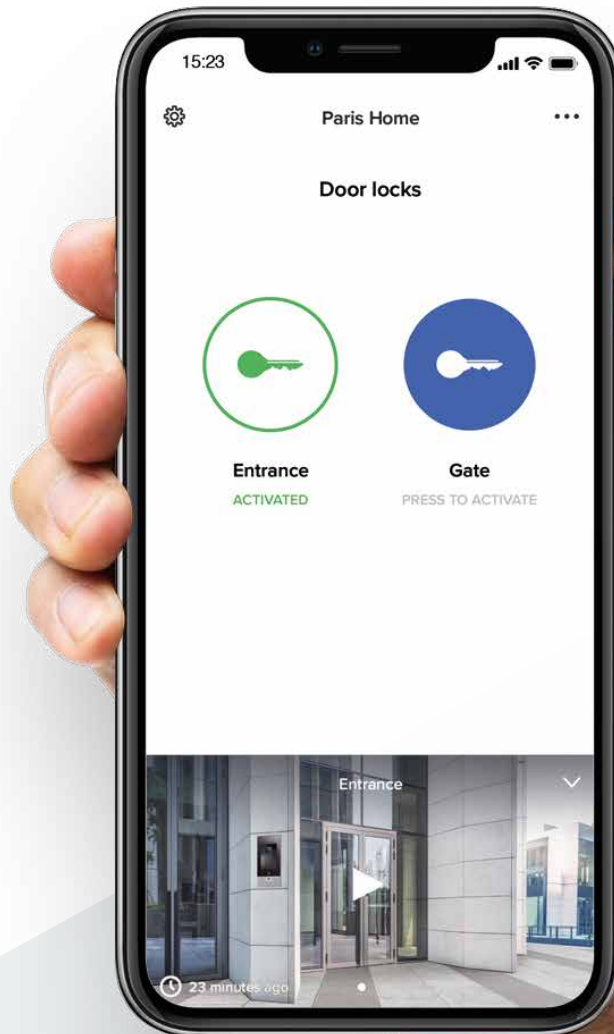

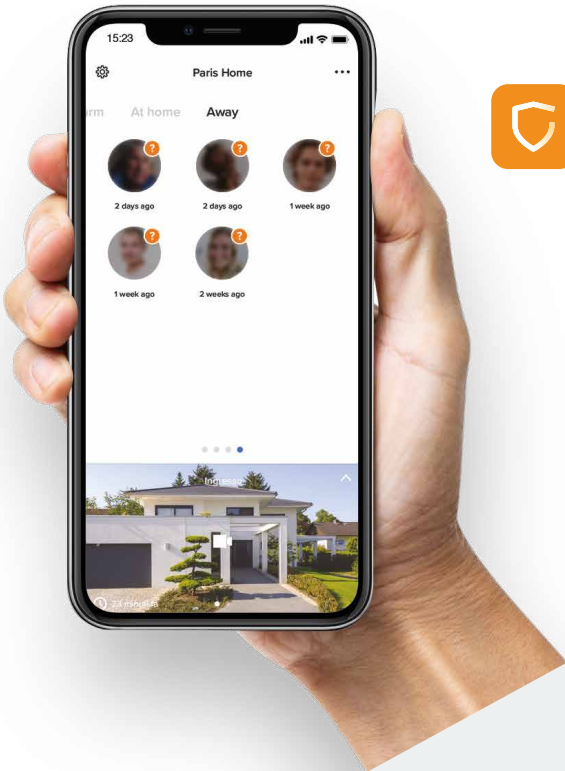

Home + Security
The best App for a safe home.

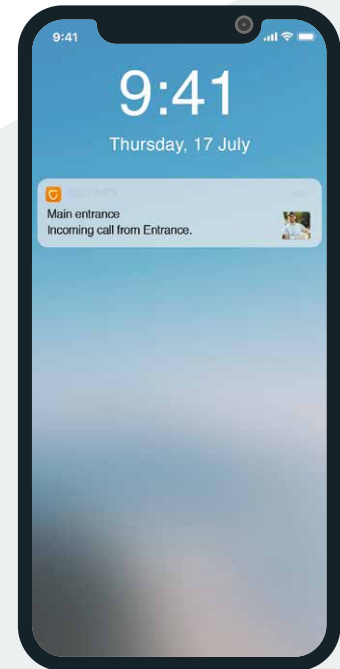

INCOMING CALL
Receive notification
when someone is calling

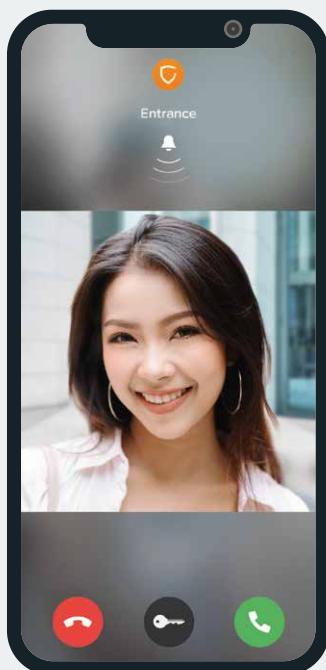

SEE WHO'S CALLING
Answer the call and
open the gate for the
courier

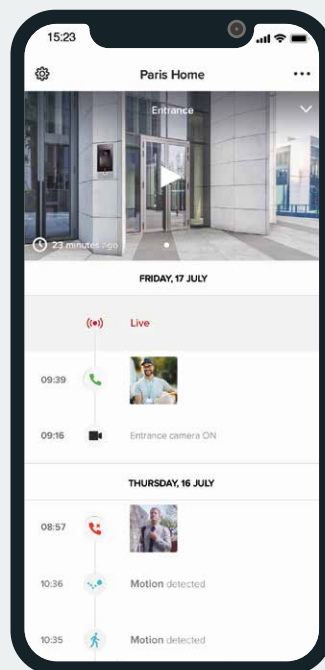

CHECK THE EVENTS
Check who called you
and if they left you
a message

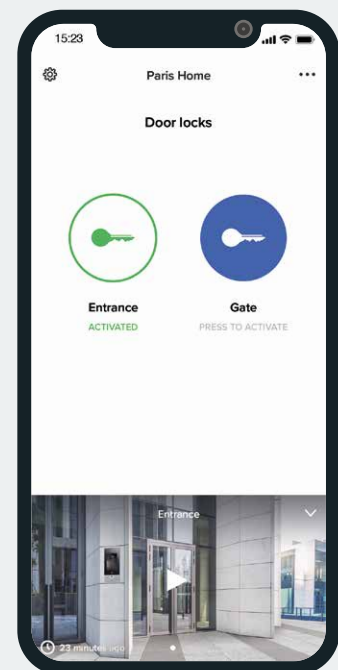

QUICK ACTIONS

- Activate the electrical door locks
- Call home / Intercom
- Activate the cameras
- Manage the answering machine

INTEGRATIONS

INTEGRATION WITH ONVIF IP CAMERAS

From the Guard Station it is possible to monitor all the common area IP cameras, while from the indoor units, the resident can monitor private and common area IP cameras.



GUARD STATION



INDOOR UNIT

INTEGRATION WITH LIFT CONTROL

Thanks to the access control function, visitors are taken directly to the floor of the called apartment while residents can call the lift from the indoor unit or when entering the building.

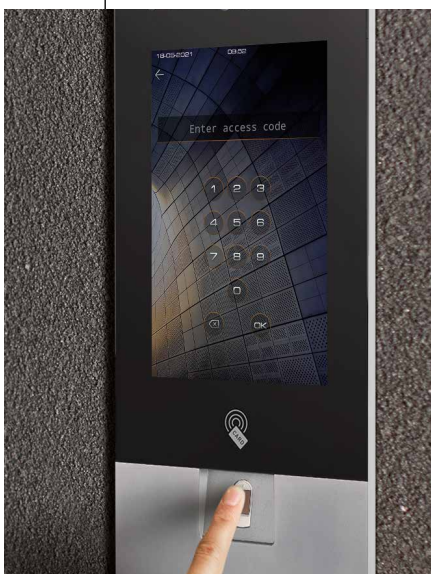

NOTE: integration to be performed through the Lift Control protocol translator and dedicated software.

IP SYSTEM

THE MAIN DEVICES

ENTRANCE PANELS	10inch TOUCH DISPLAY	4.3inch DISPLAY WITH KEYPAD	SMALL ENTRANCE PANELS
------------------------	----------------------	-----------------------------	-----------------------



Colour video	●	●	●	●	●	●	●
Finishes / Colours	Grey	Grey	Grey	Grey	Grey	Black	Grey
Flush mounted installation	With accessory BT-375007	With accessory BT-375007	With accessory BT-375006	With accessory BT-375006	With accessory BT-375008		With accessory BT-375009
Capacitive button call			●	●	●	●	
Touch display	●	●					●
Keypad			●	●			
Direct call to apartment	●	●			●	●	●
3D Face recognition	●		●				●
Fingerprint reader	●		●				
RFID Badge reader	●	●	●	●	●	●	●
Protection index	IP54	IP54	IP54	IP54	IP54	IP54	IP54
Protection index against mechanical impact	IK07	IK07	IK07	IK07	IK07	IK07	IK07



CATALOGUE

Entrance panels



374000



374002



374001



374003



374004



374006



374005

Item	Video ENTRANCE panels
374000	<p>Video entrance panel with 10" touch display, double face recognition camera, fingerprint reader and badge reader for access control functions.</p> <p>From the touch display, it is possible to make calls to the apartments and the guard station and enter the access code to release the lock. Configuration of different calling modes:</p> <ul style="list-style-type: none"> - Apartment code (Area - Building - Riser - Floor - Apartment) - Numeric or alphanumeric codes for residents - Address book with contact list <p>Enter the settings menu with a specific code for maintenance and for managing the settings (e.g. backlight brightness, ring volume, speaker volume, touch volume, screensaver time). Possibility to upload customized screensavers and advertisements using the configuration software. The entrance panel can be PoE (power over Ethernet) powered, or directly powered using power supply 375005. Flush mounted installation using the dedicated box (A)-375007.</p>
374002	<p>Video entrance panel with 10" touch display and badge reader for access control functions.</p> <p>From the touch display, it is possible to make calls to the apartments and the guard station and enter the access code to release the lock.</p> <p>Configuration of different calling modes:</p> <ul style="list-style-type: none"> - Apartment code (Area - Building - Riser - Floor - Apartment) - Numeric or alphanumeric codes for residents - Address book with contact list <p>Enter the settings menu with a specific code for maintenance and for managing the settings (e.g. backlight brightness, ring volume, speaker volume, touch volume, screensaver time). Possibility to upload customized screensavers and advertisements using the configuration software. The entrance panel can be PoE (power over Ethernet) powered, or directly powered using power supply 375005. Flush mounted installation using the dedicated box (A)-375007.</p>
374001	<p>Video entrance panel with 4.3" display, keypad with numbers and letters (A-I), double face recognition camera, fingerprint reader and badge reader for access control functions. Using the keypad, it is possible to make calls to the apartments and the guard station and enter the access code to release the lock.</p> <p>Configuration of different calling modes:</p> <ul style="list-style-type: none"> - Apartment code (Area - Building - Riser - Floor - Apartment) - Numeric or alphanumeric codes for residents <p>Enter the settings menu with a specific code for maintenance and for managing the settings (e.g. backlight brightness, ring volume, speaker volume, button volume, screensaver time). Possibility to upload customized screensavers using the configuration software. The entrance panel can be PoE (power over Ethernet) powered, or directly powered using power supply 375005. Flush mounted installation using the dedicated box (B)-375006.</p>

Item	Video ENTRANCE panels
374003	<p>Video entrance panel with 4.3" display, keypad with numbers and letters (A-I) and badge reader for access control functions.</p> <p>Using the keypad, it is possible to make calls to the apartments and the guard station and enter the access code to release the lock.</p> <p>Configuration of different calling modes:</p> <ul style="list-style-type: none"> - Apartment code (Area - Building - Riser - Floor - Apartment) - Resident's alphanumeric code <p>Enter the settings menu with a specific code for maintenance and for managing the settings (e.g. backlight brightness, ring volume, speaker volume, touch volume, screen saver time). Possibility to upload customized screensavers and advertisements using the configuration software. The entrance panel can be PoE (power over Ethernet) powered, or directly powered using power supply 375005. Flush mounted installation using the dedicated box (B)-375006.</p>
374004	<p>Small video entrance panel for indoor installation with badge reader and key for indoor unit and guard station calls. The small video entrance panel can be PoE (power over Ethernet) powered, or directly powered using power supply 375005. Flush mounted installation using the dedicated box (C)-375008.</p>
374005	<p>Small video entrance panel with 4.3" vertical touch display, face recognition and badge reader for access control functions.</p> <p>From the touch display, it is possible to make calls to the apartments and the guard station and enter the access code to release the lock.</p> <p>Configuration of different calling modes:</p> <ul style="list-style-type: none"> - Apartment code (Area - Building - Riser - Floor - Apartment) - Numeric or alphanumeric codes for residents - Address book with contact list <p>Settings menu for maintenance and for managing settings (e.g. backlight brightness, ring volume, speaker volume, touch volume, screensaver time). Possibility to upload customized screensavers using the configuration software. This device can be PoE (power over Ethernet) powered, or directly powered using power supply 375005. Flush mounted installation using the dedicated box (D)-375009.</p>
374006	<p>Small video entrance panel with RFID badge reader and key for indoor unit and guard station calls. The small video entrance panel can be PoE (power over Ethernet) powered, or directly powered using power supply 375005. Wall mounted installation thanks to the support with rainshield included.</p>

(A) - (B) - (C) - (D) - Correspondence with the specific flush-mounted box - see accessories page.

IP SYSTEM

THE MAIN DEVICES

PREMIUM INDOOR UNITS	10inch TOUCH DISPLAY		7inch TOUCH DISPLAY	



373001



373003



373002



373004

Touch screen colour video	•	•	•	•
Handsfree	•	•	•	•
Finishes / Colours	Grey	Grey	Grey	Grey
Display	LCD 10inch	LCD 10inch	LCD 7inch	LCD 7inch
Indoor camera	•		•	
Answering machine	•	•	•	•
Alarm management	•	•	•	•
SOS function	•	•	•	•
Door lock release	•	•	•	•
Entrance panel camera activation	•	•	•	•
Intercom	•	•	•	•
Integration with Home+Securityapp	•	•	•	•
Audio messages	•	•	•	•
Type of installation	Wall mounted	Wall mounted	Wall mounted	Wall mounted
Power supply	375005 375002	375005 375002	375005 375002	375005 375002

**STANDARD
INDOOR
UNITS**
**7inch
TOUCH DISPLAY**

373005



373006



373007



373008

Touch screen colour video	•	•	•	•
Handsfree	•	•	•	•
Finishes / Colours	Black	Champagne Gold	Mirror	Black
Display	LCD 7inch	LCD 7inch	LCD 7inch	LCD 7inch
Indoor camera				
Answering machine	•	•	•	•
Alarm management	•	•	•	•
SOS function				
Door lock release	•	•	•	•
Entrance panel camera activation	•	•	•	•
Intercom	•	•	•	•
Integration with Home + Security app	•	•	•	•
Audio messages	•	•	•	•
Type of installation	Wall mounted	Wall mounted	Wall mounted	Wall mounted
Power supply	PoE 375002	PoE 375002	PoE 375002	Standard PoE +

IP SYSTEM CATALOGUE

Premium indoor units



373001



373002



373003



373004

Item	Video INDOOR unit
373001	<p>10" touch display premium indoor unit with internal camera and SOS pushbutton.</p> <p>From the touch display, it is possible to answer the call, open the lock, call the other apartments and the guard station, view call and alarm logs, leave audio messages, receive messages from the guard station, adjust the settings (e.g. brightness, screensaver, backgrounds and ringtone) and view date/time information. Alarm management can be easily integrated thanks to 8 pre-arranged dedicated contacts. The integration with the Onvif IP cameras allows to view the IP cameras of the apartment and the common areas from the indoor unit. The specific integration also allows control of the lift. It is possible to associate the video indoor unit to the Home + Security App (available for Android and iOS). The App allows to use functions such as: receiving calls, door lock release, display of the event timeline and activation of the entrance panel. With the Home + Security App, it is also possible to manage the products of the Netatmo Security range (outdoor and indoor cameras, door and window sensors, indoor siren, smoke detector). This allows you to quickly and easily create a Smart security system. The indoor unit can be PoE (power over Ethernet) powered, or directly powered using power supply 375005. Wall mounted using the supplied bracket.</p>
373002	<p>7" touch display premium indoor unit with internal camera and SOS pushbutton.</p> <p>From the touch display, it is possible to answer the call, open the lock, call the other apartments and the guard station, view call and alarm logs, leave audio messages, receive messages from the guard station, adjust the settings (e.g. brightness, screensaver, backgrounds and ringtone) and view date/time information. Alarm management can be easily integrated thanks to 8 pre-arranged dedicated contacts. The integration with the Onvif IP cameras allows to view the IP cameras of the apartment and the common areas from the indoor unit. The specific integration also allows control of the lift. It is possible to associate the video indoor unit to the Home + Security App (available for Android and iOS). The App allows to use functions such as: receiving calls, door lock release, display of the event timeline and activation of the entrance panel. With the Home + Security App, it is also possible to manage the products of the Netatmo Security range (outdoor and indoor cameras, door and window sensors, indoor siren, smoke detector). This allows you to quickly and easily create a Smart security system. The indoor unit can be PoE (power over Ethernet) powered, or directly powered using power supply 375005. Wall mounted using the supplied bracket.</p>

Item	Video INDOOR unit
373003	<p>10" touch display premium indoor unit with SOS pushbutton. From the touch display, it is possible to answer the call, open the lock, call the other apartments and the guard station, view call and alarm logs, leave audio messages, receive messages from the guard station, adjust the settings (e.g. brightness, screensaver, backgrounds and ringtone) and view date/time information. Alarm management can be easily integrated thanks to 8 pre-arranged dedicated contacts. The integration with the Onvif IP cameras allows to view the IP cameras of the apartment and the common areas from the indoor unit. The specific integration also allows control of the lift. It is possible to associate the video indoor unit to the Home + Security App (available for Android and iOS). The App allows to use functions such as: receiving calls, door lock release, display of the event timeline and activation of the entrance panel. With the Home + Security App, it is also possible to manage the products of the Netatmo Security range (outdoor and indoor cameras, door and window sensors, indoor siren, smoke detector). This allows you to quickly and easily create a Smart security system. The indoor unit can be PoE (power over Ethernet) powered, or directly powered using power supply 375005. Wall mounted using the supplied bracket.</p>
373004	<p>7" touch display premium indoor unit with SOS pushbutton. From the touch display, it is possible to answer the call, open the lock, call the other apartments and the guard station, view call and alarm logs, leave audio messages, receive messages from the guard station, adjust the settings (e.g. brightness, screensaver, backgrounds and ringtone) and view date/time information. Alarm management can be easily integrated thanks to 8 pre-arranged dedicated contacts. The integration with the Onvif IP cameras allows to view the IP cameras of the apartment and the common areas from the indoor unit. The specific integration also allows control of the lift. It is possible to associate the video indoor unit to the Home + Security App (available for Android and iOS). The App allows to use functions such as: receiving calls, door lock release, display of the event timeline and activation of the entrance panel. With the Home + Security App, it is also possible to manage the products of the Netatmo Security range (outdoor and indoor cameras, door and window sensors, indoor siren, smoke detector). This allows you to quickly and easily create a Smart security system. The indoor unit can be PoE (power over Ethernet) powered, or directly powered using power supply 375005. Wall mounted using the supplied bracket.</p>



Standard indoor units



373005



373006



373007



373008

Item	Video INDOOR unit
373005	<p>7" touch display standard indoor unit, black finishing.</p> <p>From the touch display, it is possible to answer the call, open the lock, call the other apartments and the guard station, view call and alarm logs, leave audio messages, receive messages from the guard station, adjust the settings (e.g. brightness and ringtone) and view date/time information. Alarm management can be easily integrated thanks to 8 pre-arranged dedicated contacts. The integration with the Onvif IP cameras allows to view the IP cameras of the apartment and the common areas from the indoor unit. The specific integration also allows control of the lift. It is possible to associate the video indoor unit to the Home + Security App (available for Android and iOS). The App allows to use functions such as: receiving calls, door lock release, display of the event timeline and activation of the entrance panel. With the Home + Security App, it is also possible to manage the products of the Netatmo Security range (outdoor and indoor cameras, door and window sensors, indoor siren, smoke detector). This allows you to quickly and easily create a Smart security system. The indoor unit can be PoE (power over Ethernet) powered, or directly powered using power supply 375005. Wall mounted using the supplied bracket.</p>
373006	<p>7" touch display standard indoor unit, champagne gold finishing.</p> <p>From the touch display, it is possible to answer the call, open the lock, call the other apartments and the guard station, view call and alarm logs, leave audio messages, receive messages from the guard station, adjust the settings (e.g. brightness and ringtone) and view date/time information. Alarm management can be easily integrated thanks to 8 pre-arranged dedicated contacts. The integration with the Onvif IP cameras allows to view the IP cameras of the apartment and the common areas from the indoor unit. The specific integration also allows control of the lift. It is possible to associate the video indoor unit to the Home + Security App (available for Android and iOS). The App allows to use functions such as: receiving calls, door lock release, display of the event timeline and activation of the entrance panel. With the Home + Security App, it is also possible to manage the products of the Netatmo Security range (outdoor and indoor cameras, door and window sensors, indoor siren, smoke detector). This allows you to quickly and easily create a Smart security system. The indoor unit can be PoE (power over Ethernet) powered, or directly powered using power supply 375005. Wall mounted using the supplied bracket.</p>

Item	Video INDOOR unit
373007	<p>7" touch display standard indoor unit, mirror finishing.</p> <p>From the touch display, it is possible to answer the call, open the lock, call the other apartments and the guard station, view call and alarm logs, leave audio messages, receive messages from the guard station, adjust the settings (e.g. brightness and ringtone) and view date/time information. Alarm management can be easily integrated thanks to 8 pre-arranged dedicated contacts. The integration with the Onvif IP cameras allows to view the IP cameras of the apartment and the common areas from the indoor unit. The specific integration also allows control of the lift. It is possible to associate the video indoor unit to the Home + Security App (available for Android and iOS). The App allows to use functions such as: receiving calls, door lock release, display of the event timeline and activation of the entrance panel. With the Home + Security App, it is also possible to manage the products of the Netatmo Security range (outdoor and indoor cameras, door and window sensors, indoor siren, smoke detector). This allows you to quickly and easily create a Smart security system. The indoor unit can be PoE (power over Ethernet) powered, or directly powered using power supply 375005. Wall mounted using the supplied bracket.</p>
373008	<p>7" PoE powered standard indoor unit, black finish</p> <p>From the touch display, it is possible to answer the call, open the lock, call the other apartments and the guard station, view call and alarm logs, leave audio messages, receive messages from the guard station, adjust the settings (e.g. brightness and ring tone), and view date/time information. Alarm management can be easily integrated thanks to 8 pre-arranged dedicated contacts. The integration with the Onvif CCTV IP cameras allows to view the IP cameras of the apartment and the common area from the indoor unit. The specific integration also allows control of the lift. It is possible to associate the video indoor unit to the Home + Security App (available for Android and iOS). The App allows to use functions such as: receiving calls, door lock release, display of the event timeline and activation of the entrance panel. With the Home + Security App, it is also possible to manage the products of the Netatmo Security range (outdoor and indoor cameras, door and window sensors, indoor siren, smoke detector). This allows you to quickly and easily create a Smart security system. The indoor unit is 48V PoE (power over Ethernet) powered. Wall mounted using the supplied bracket.</p>

IP SYSTEM CATALOGUE

Guard station and accessories



375000



375001



348200



348201



348202



348203



348204



348205



348206

Item **Guard station**

375000 **Guard station with 10" touch display and handset.**

From the touch display, it is possible to: answer and transfer calls, view call logs, release the locks, monitor IP cameras installed in common areas, monitor and process alarms.

From the setting menu, it is possible to adjust the guard station settings, like volume and display brightness, and carry out functionality and network tests. Quick and scheduled absence can be activated to transfer the call to another guard station or to apartments if needed. The guard station can be PoE (power over Ethernet) powered, or directly powered using power supply [375005](#).

Accessories

375001 **Server DES (Door Entry System) including configuration and management software** must be installed in the building under the VLAN network of the IP door entry system.

The configuration software must be used to create, configure and update the entire installation. The software can be used to create the topology; entrance panels, guard station and indoor units are associated to the corresponding position in an easy and quick way using a scan tool. It also allows the programming of access control tools such as: RFID badges, card, fingerprint and face recognition.

The software is also used to: program access control for new residents, view alarm logs, send messages to indoor units, upload advertisements and screensavers and synchronize time/date details on all devices.

375003 **Reader for programming card and badges for building access control.** Compatible with RFID badges [348200](#) to [..06](#) available in different colors. Programming and associating badges to residents requires the use of the configuration software.

375004 **Reader for programming fingerprints for building access control.** Registering and associating the residents' fingerprints requires the use of the configuration software.

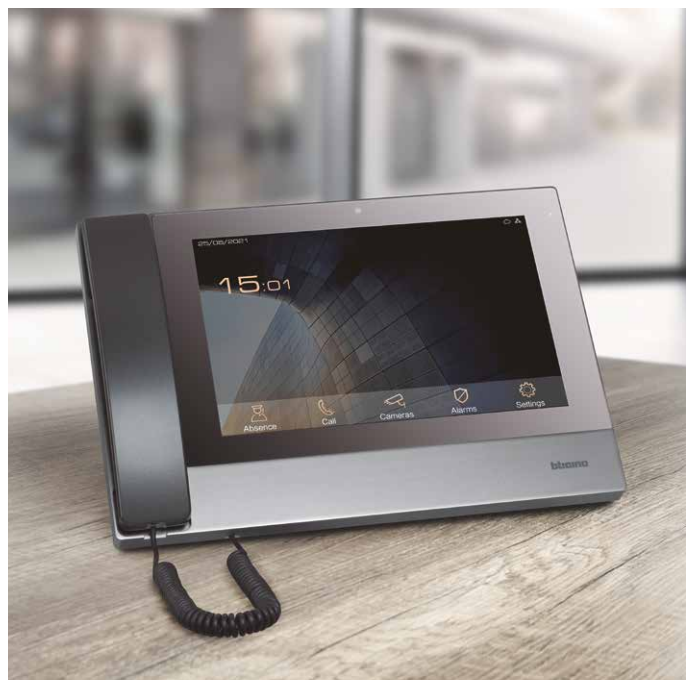

Transponder badge keys

		Pack
348200	● Black	10
348201	● Red	10
348202	● Green	10
348203	● Blue	10
348204	● Orange	10
348205	● Grey	10
348206	● Yellow	10

Accessories



Item	Accessories
375002	PoE (Power over Ethernet) switch with 10 / 100 Mbps, 8 PoE ports and 1 non-POE port uplink and 24 V-100 W power supply. The PoE port is used for network communication and as power supply. DIN mounted installation (Total of 14 DIN modules).
375005	Power supply 100 W with metal box; can be operate as an auxiliary power supply. Protected against short circuits: in case of DC output short circuit, the device will switch to protected mode. Wall mounted installation.
375006	(B) Metal box for video entrance panel with 4.3" display and keypad, flush mounted installation. Compatible with Cat.No: - 374001 video entrance panel with 4.3" display and keypad, with face recognition and fingerprint - 374003 video entrance panel with 4.3" display and keypad
375007	(A) Metal box for video entrance panel with 10" touch display, flush mounted installation. Compatible with Cat.No: - 374000 video entrance panel with 10" touch display with face recognition and fingerprint - 374002 video entrance panel with 10" touch display
375008	(C) Metal box for small video entrance panel flush mounted installation. Compatible with Cat.No: 374004
375009	(D) Metal box for small video entrance panel with 4.3" vertical touch display, flush mounted installation. Compatible with Cat.No: 374005
375010	Lift control interface with protocol translator to integrate lift function in IP door entry system. The configuration is completed using a dedicate software, the interface is connected via RS 485 cable to the entrance panel and the lift.
375011	USB key to be inserted on DES Server 375001 to enable face registration and to provide access mode for face recognition in the installation. At least one of the following devices must be present in the installation: external pushbutton panel with 10" touch display with face recognition and fingerprint (374000), external pushbutton panel with keyboard, facial recognition and fingerprint (374001) or Small pushbutton panel with 4.3 "touch display (374005).
SP111	Plug-in power supply for IP server 375001. Input 100 240 Vac @ 50 60 Hz. Output 19 Vdc. Length of connection cable with IP server = 1200 mm

Item	Accessories
375012	PoE converter for BTicino IP DES devices with 24 V PoE to be installed in standard PoE + network.
375013	Lift control interface with 8 relay to integrate the IP DES with the building elevator system in order to enable the lift call after the resident answer the call and open the gate. The configuration is made directly in IP DES configuration tool included in Server DES 375001. NOTE : INSTALLATION AND CONNECTIONS MUST BE ALWAYS PERFORMED ACCORDINGLY TO THE ELEVATOR TYPE.



(A) - (B) - (C) - (D) - Correspondence with the related entrance panels - see entrance panels page.

IP SYSTEM

WIRING DIAGRAM EXAMPLE

System architecture

LAN Ethernet

LAN PoE BTicino

LAN PoE Standard

Apartment X
Building 1

Apartment 2
Building 1



See note (*)

Apartment 1
Building 1



See note (*)

Entrance panel + Guard station
Building 1



See note (*)

PoE Switch BTicino
Building 1



100-240 Va.c.

UP LINK

LAN PoE BTicino
Building XX

PoE Switch BTicino
Building XX



100-240 Va.c.

UP LINK

Server DES with PC Client



ONVIF IP cameras



Standard PoE switch



INTERNET

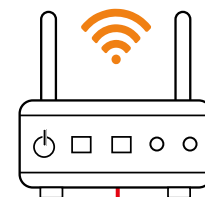

Modem router

Network switch

note (*): provide a PoE LAN cable for each BTicino device.

Standard PoE + compatibility

- Indoor unit **373008** natively compatible with standard PoE+ (RJ45 10/100 Base T - IEEE 802.3at POE 44 V-57 V)
- For all other devices it is possible to use PoE converter accessory **375012**.

LAN Ethernet

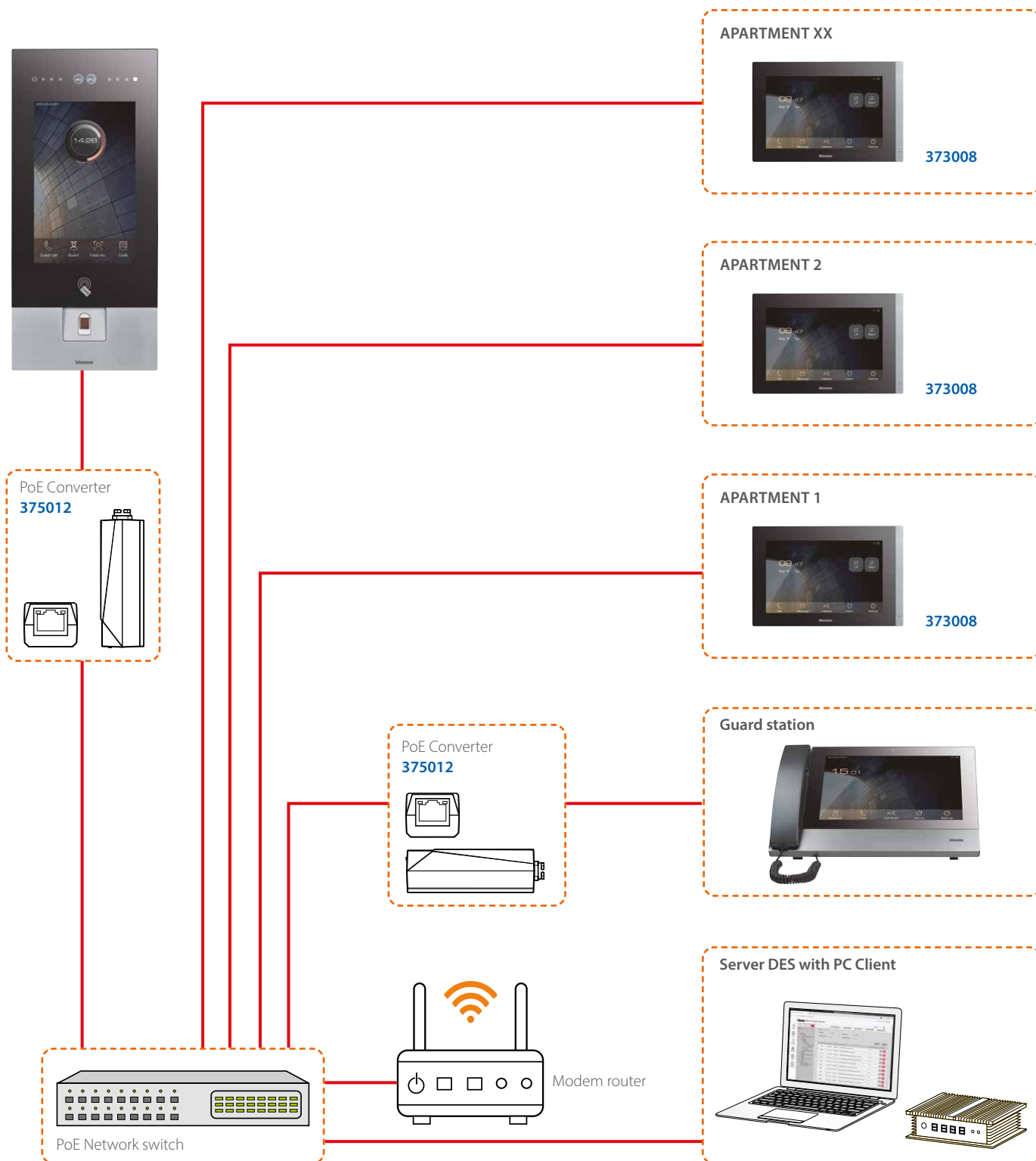

note (*): provide a PoE LAN cable for each BTicino device.

IP SYSTEM WIRING DIAGRAM EXAMPLE

Fiber optic riser connection

- Fiber optic
- LAN Ethernet
- LAN PoE BTicino
- 2 x Copper cables

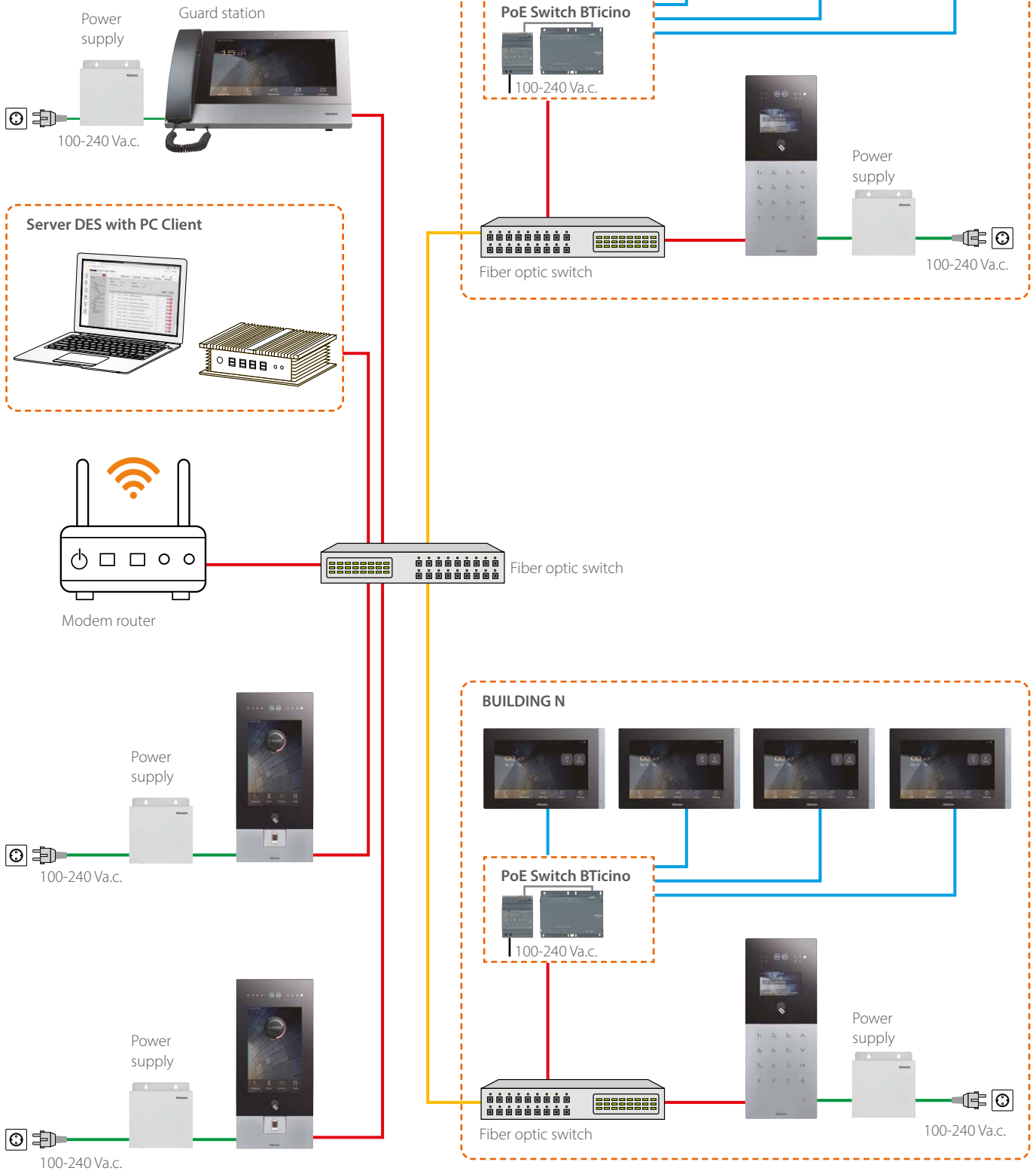

Intercom function

INTERCOM FUNCTIONS

- audio intercom between indoor units:
- of different apartments (same building or different buildings)
 - inside the same apartment

LAN Ethernet

LAN PoE BTicino

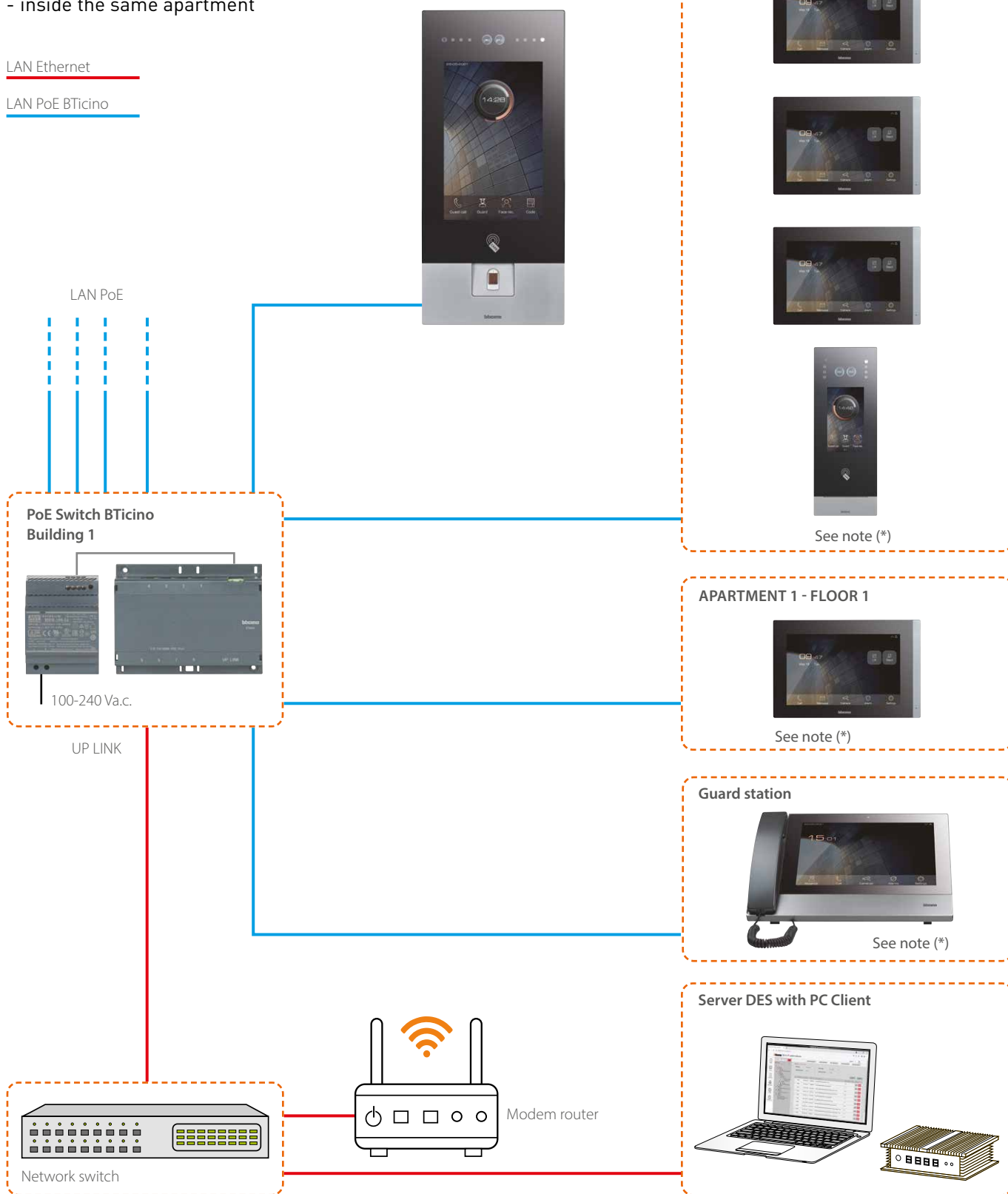

note (*): provide a PoE LAN cable for each BTicino device.

IP SYSTEM

WIRING DIAGRAM EXAMPLE

Alarms integration

ALARM FUNCTIONS

The guard station receives all the alarm notification messages, including the SOS alerts coming from the indoor units.

LAN Ethernet

LAN PoE BTicino

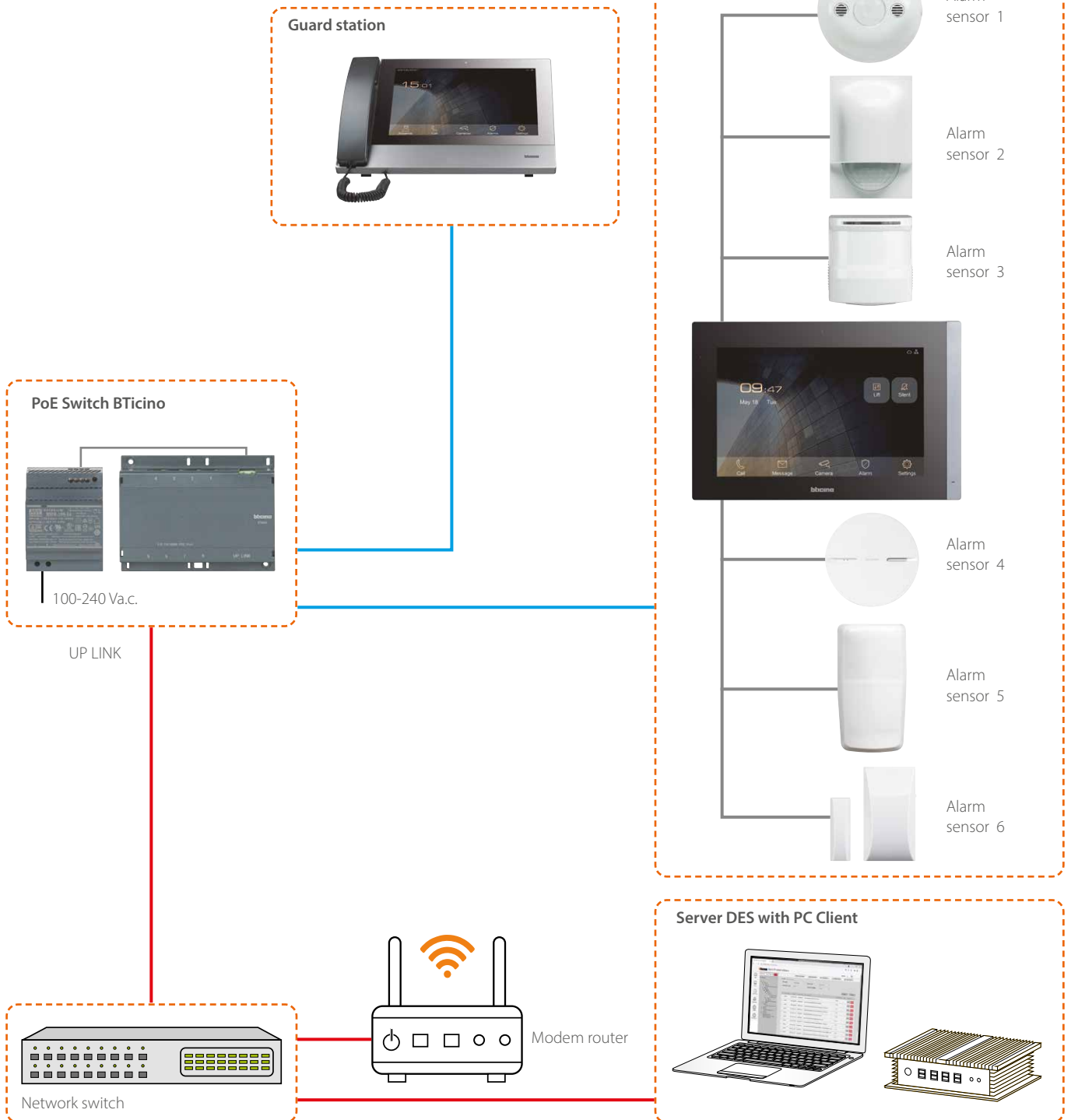

NOTE

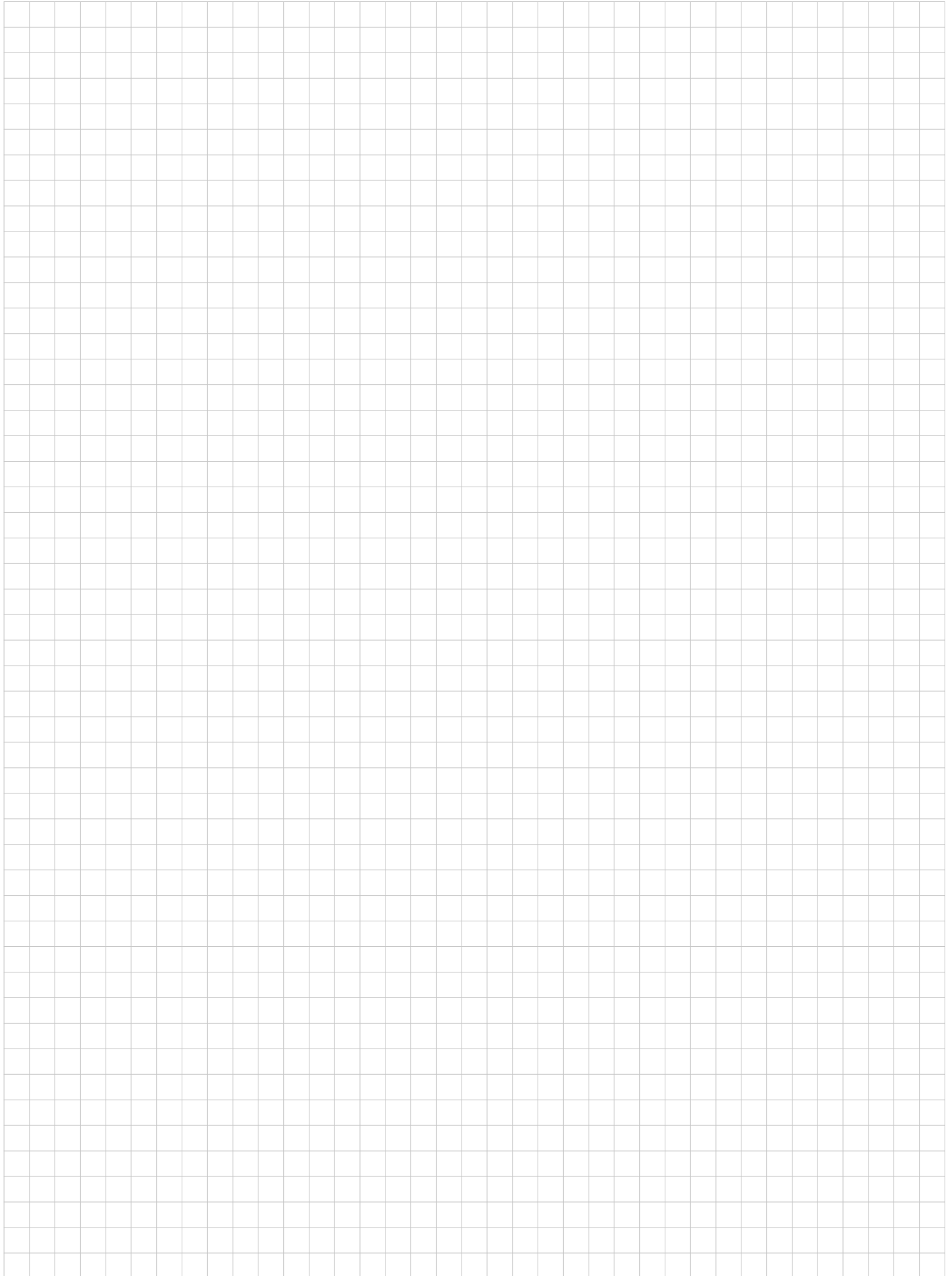

NOTE



BTicino SpA
Viale Borri, 231
21100 Varese - Italy
www.bticino.com

BTicino SpA reserves at any time the right to modify the contents of this booklet and to communicate, in any form and modality, the changes brought to the same.

AD-EXCM23VDEC/ENG - Edition 10/2023

bticino

A Group brand |  **legrand**